

# nLite Wireless 11n Broadband Router

BR-6324n / BR-6324nL

User Manual

Version 1.0 / April 2008



Copyright© by Edimax Technology Co, LTD. all rights reserved. No part of this publication may be reproduced, transmitted, transcribed, stored in a retrieval system, or translated into any language or computer language, in any form or by any means, electronic, mechanical, magnetic, optical, chemical, manual or otherwise, without the prior written permission of this Company .

This company makes no representations or warranties, either expressed or implied, with respect to the contents hereof and specifically disclaims any warranties, merchantability or fitness for any particular purpose. Any software described in this manual is sold or licensed "as is". Should the programs prove defective following their purchase, the buyer (and not this company, its distributor, or its dealer) assumes the entire cost of all necessary servicing, repair, and any incidental or consequential damages resulting from any defect in the software. Further, this company reserves the right to revise this publication and to make changes from time to time in the contents hereof without obligation to notify any person of such revision or changes.

The product you have purchased and the setup screen may appear slightly different from those shown in this QIG. For more detailed information about this product, please refer to the User Manual on the CD-ROM. The software and specifications are subject to change without notice. Please visit our web site [www.edimax.com](http://www.edimax.com) for the update. All rights reserved including all brand and product names mentioned in this manual are trademarks and/or registered trademarks of their respective holders .

### Linux Open Source Code

Certain Edimax products include software code developed by third parties, software code is subject to the GNU General Public License ("GPL") or GNU Lesser General Public License ("LGPL"). Please see the **GNU** ([www.gnu.org](http://www.gnu.org)) and **LPGL**([www.gnu.org](http://www.gnu.org)) Websites to view the terms of each license.

The GPL Code and LGPL Code used in Edimax products are distributed without any warranty and are subject to the copyrights of their authors. For details, see the GPL Code and LGPL Code licenses. You can download the firmware-files at <http://www.edimax.com> under "Download" page.

# CATALOG

<i>Chapter I: Product Information</i> .....	6
1-1 Introduction and safety information .....	6
1-2 Safety Information .....	8
1-3 System Requirements .....	9
1-4 Package Contents.....	10
1-5 Familiar with your new wireless broadband router .....	11
<i>Chapter II: System and Network Setup</i> .....	13
2-1 Establish network connection.....	13
2-2 Setup client computers to obtain IP address automatically .....	15
2-2-1 Windows 95/98/Me IP address setup: .....	16
2-2-2 Windows 2000 IP address setup:.....	18
2-2-3 Windows XP IP address setup: .....	20
2-2-4 Windows Vista IP address setup: .....	22
2-3 Connect to broadband router by web browser.....	24
2-4 Using 'Quick Setup' .....	28
2-4-1 Using 'Cable Modem' as broadband connection type.....	32
2-4-2 Using 'Fixed-IP xDSL' as broadband connection type .....	34
2-4-3 Using 'PPPoE xDSL' as broadband connection type.....	36
2-4-4 Using 'PPTP xDSL' as broadband connection type .....	38
2-4-5 Using 'L2TP xDSL' as broadband connection type.....	41
2-4-6 Using 'Telstra Big Pond' as broadband connection type .....	44
<i>Chapter III: General Setup</i> .....	46
3-1 System .....	48
3-1-1 Time Zone .....	48
3-1-2 Password Settings.....	50
3-1-3 Remote Management.....	51
3-2 WAN .....	53
3-2-2 Static IP .....	56
3-2-3 PPPoE.....	58
3-2-4 PPTP.....	60
3-2-5 L2TP.....	63
3-2-5 L2TP.....	63
3-2-6 Telstra Big Pond .....	66
3-3 LAN (Wired) .....	68
3-3-1 Before you start - Suggestions for deciding an IP address to be used with this broadband router .....	68
3-3-2 LAN IP .....	70

3-3-3 DHCP Server .....	71
3-3-4 Static DHCP Leases .....	72
3-4 Wireless .....	74
3-4-1 Basic Settings .....	75
3-4-1-1 AP mode .....	76
3-4-1-2 Station-Infrastructure .....	79
3-4-1-3 AP Bridge-Point to Point.....	82
3-4-1-4 AP Bridge-Point to Multi-Point .....	85
3-4-1-5 AP Bridge-WDS.....	87
3-4-1-6 Universal Repeater.....	90
3-4-1-7 Set Security .....	94
3-4-2 Security Settings.....	98
3-4-4 WPS.....	105
3-5 Advance Settings* .....	107
3-5-1 QoS.....	108
3-5-1-1 Basic QoS Settings.....	108
3-5-1-2 Add a new QoS entry .....	110
3-5-2 NAT .....	112
3-5-2-1 Virtual Server .....	112
3-5-2-2 Special Applications.....	115
3-5-2-3 Firewall .....	118
3-5-2-3-1 Access Control.....	118
3-5-2-3-2 URL Blocking.....	124
3-5-2-3-3 DoS .....	127
3-5-2-4 DDNS.....	130
3-5-2-5 Port Forwarding .....	133
3-5-2-6 DMZ.....	136
<i>Chapter IV EZ View .....</i>	139
<i>Chapter V Status .....</i>	147
5-1 Internet Connection .....	149
5-2 Device Status .....	150
5-3 System Log .....	151
5-4 Security Log .....	152
5-5 Active DHCP Client .....	153
5-6 <i>Statistics</i> .....	154
<i>Chapter VI Tools .....</i>	155
6-1 Configuration Tools .....	157
6-2 Firmware Upgrade.....	158
6-3 Restart.....	159
<i>Chapter VII Language .....</i>	160



# *Chapter I: Product Information*

## 1-1 Introduction and safety information

Thank you for purchasing Edimax BR-6324nL wireless 11b/g broadband router! This high cost-efficiency router is the best choice for ***Small office / Home office*** users, all computers and network devices can share a single xDSL / cable modem internet connection at high speed. Easy install procedures allows any computer users to setup a network environment in very short time - within minutes, even inexperienced. When the number of your computers and network-enabled devices grow, you can also expand the number of network slot by simple attach a hub or switch, to extend the scope of your network!

With built-in IEEE 802.11b/g wireless network capability, all computers and wireless-enabled network devices (*including PDA, cellular phone, game console, and more!*) can connect to this broadband router without additional cabling. ***New Draft-N wireless capability also gives you the highest speed of wireless experience ever! With a compatible wireless card installed in your PC, you can transfer file for up to 150 Mbps! The radio coverage is also doubled, so don't worry if your office or house is really big!***

*Other features of this router including:*

- High Internet Access throughput
- Allow multiple users to share a single Internet connection
- Supports up to 253 LAN users sharing a single Cable or xDSL internet connection
- Four wired LAN ports (10/100Mbps) and one WAN port (10/100Mbps)
- Provides IEEE 802.11b/g wireless LAN capability
- Support DHCP (Server/Client) for easy client IP-address setup
- Advanced network and security features like: Special Applications, DMZ, Virtual Servers, Access Control, Firewall.
- Allow you to monitor the router's status like: DHCP Client Log, System Log, Security Log and Device/Connection Status

- Easy to use Web-based GUI for network configuration and management purposes
- Remote management function allows configuration and upgrades from a remote computer (over the Internet)
- Auto MDI / MDI-X function for all wired Ethernet ports.

## 1-2 Safety Information

In order to keep the safety of users and your properties, please follow the following safety instructions:

1. This router is designed for indoor use only; **DO NOT** place this router outdoor.
2. **DO NOT** put this router at or near hot or humid places, like kitchen or bathroom. Also, do not left this router in the car in summer.
3. **DO NOT** pull any connected cable with force; disconnect it from the router first.
4. If you want to place this router at high places or hang on the wall, please make sure the router is firmly secured. Falling from high places would damage the router and its accessories, and warranty will be void.
5. Accessories of this router, like antenna and power supply, are danger to small children under 3 years old. They may put the small parts in their nose or month and it could cause serious damage to them. **KEEP THIS ROUTER OUT THE REACH OF CHILDREN!**
6. The router will become hot when being used for long time (***This is normal and is not a malfunction***), **DO NOT** put this router on paper, cloth, or other flammable materials.
7. There's no user-serviceable part inside the router. If you found that the router is not working properly, please contact your dealer of purchase and ask for help. **DO NOT** disassemble the router, warranty will be void.
8. If the router falls into water when it's powered, **DO NOT** use your hand to pick it up. Switch the electrical power off before you do anything, or contact an experienced technician for help.
9. If you smell something strange, or even see some smoke coming out from the router or power supply, remove the power supply or switch the electrical power off immediately, and call dealer of purchase for help.

## 1-3 System Requirements

- Internet connection, provided by xDSL or cable modem with a RJ-45 Ethernet port.
- Computer or network devices with wired or wireless network interface card.
- Web browser (*Microsoft Internet Explorer 4.0 or above, Netscape Navigator 4.7 or above, Opera web browser, or Safari web browser*).
- An available power socket

## 1-4 Package Contents

Before you starting to use this router, please check if there's anything missing in the package, and contact your dealer of purchase to claim for missing items:

- Router with Antennas (main body, 1 pcs)..... 1
- Quick installation guide (1 pcs) ..... 2
- CDROM (with multi-languages setup wizard, multi-languages Quick installation guide and User manual )(1 pcs) ..... 3
- 12V 1A power adapter (1 pcs)..... 4
- Ethernet Cable (1 pcs)..... 5
- Accessories (1 pcs)..... 6

You can configure the router by running the Setup Wizard in the CD-ROM provided in the package. The wizard provides quick setup for the Internet connection, SSID, wireless security, firmware upgrade and changing router's password. When you start the Setup Wizard, you will get the following Welcome screen. Please choose the language to start with and follow the easy steps in the Wizard. No instruction for the Setup Wizard is given here.



If you lost the CD-ROM or you prefer the traditional web setup, please follow the procedures in this Manual ( or Quick Installation Guide ) to configure the router



## 1-5 Familiar with your new wireless broadband router

### *Front Panel*



LED Name	Light Status	Description
PWR 	ON	Router is switched on and correctly powered
WLAN 	On	Wireless network is switched on
	Off	Wireless network is switched off
	Flashing	Wireless LAN activity (transferring data) or WPS mode is on. (LED will on and off every 1 second)
WAN	On	WAN port is connected
	Off	WAN port is not connected
LNK/ACT	Flashing	WAN activity (transferring data)
LAN	On	LAN port is connected
	Off	LAN port is not connected
LNK/ACT	Flashing	LAN activity (transferring data)

## Back Panel

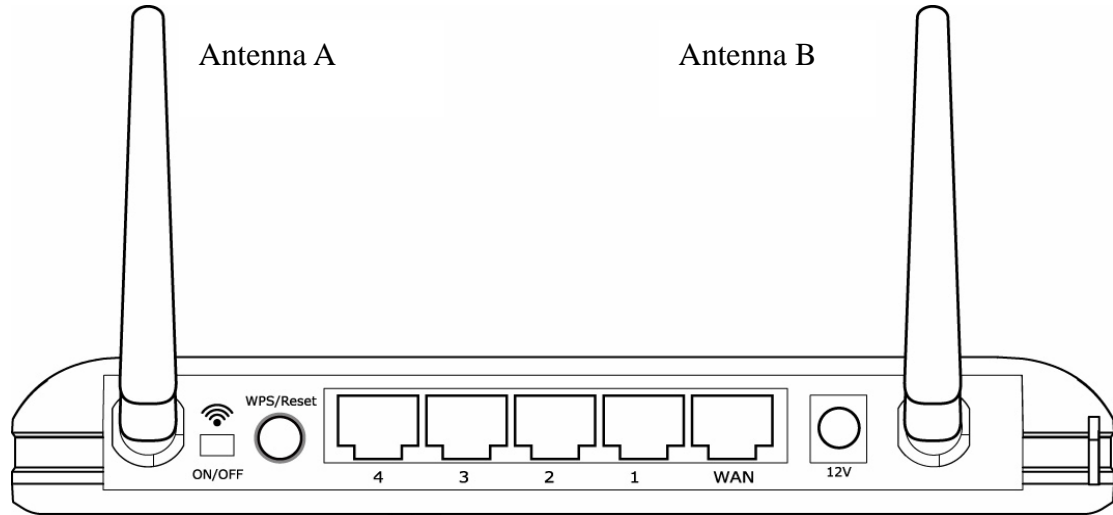

BR-6324nL

Item Name	Description
Antennas	Antenna A, B
 ON/OFF	Enable / Disable wireless signal You can not connect the router via wireless adapter, when you disable the wireless signal,
12V (Power)	Power connector, connects to power adapter
Reset / WPS	Reset the router to factory default settings (clear all settings) or start WPS function. Press this button and hold for 20 seconds to clear all settings, and press this button for less than 5 seconds to start WPS function.
1 - 4	Local Area Network (LAN) ports 1 to 4
WAN	Wide Area Network (WAN / Internet) port

## Chapter II: System and Network Setup

### 2-1 Establish network connection

Please follow the following instruction to build the network connection between your new Broadband router and your computers, network devices:

1. Connect your xDSL / cable modem to the WAN port of router by Ethernet cable.

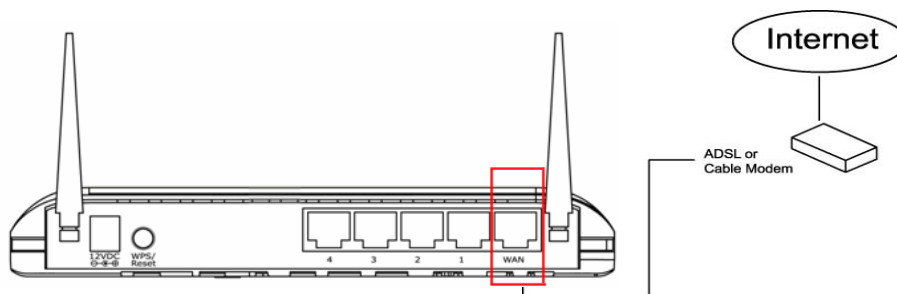

2. Connect all your computers, network devices (network-enabled consumer devices other than computers, like game console, or switch / hub) to the LAN port of the router.

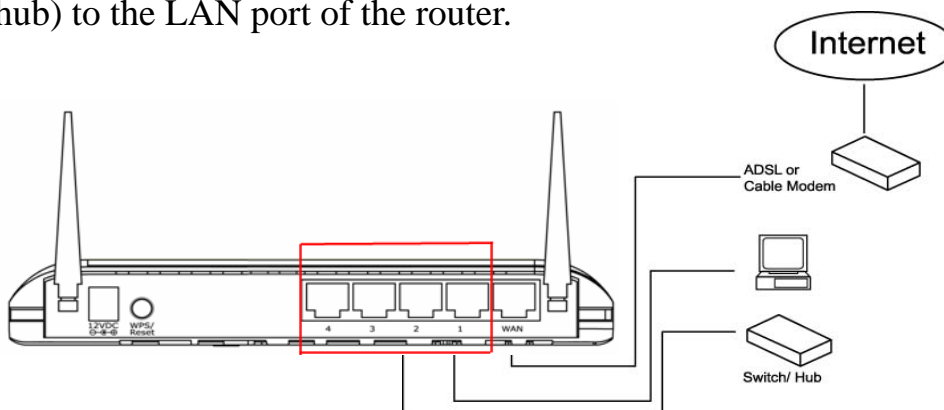

3. Connect the power adapter to the wall socket, and then connect it to the 'Power' socket of the router.

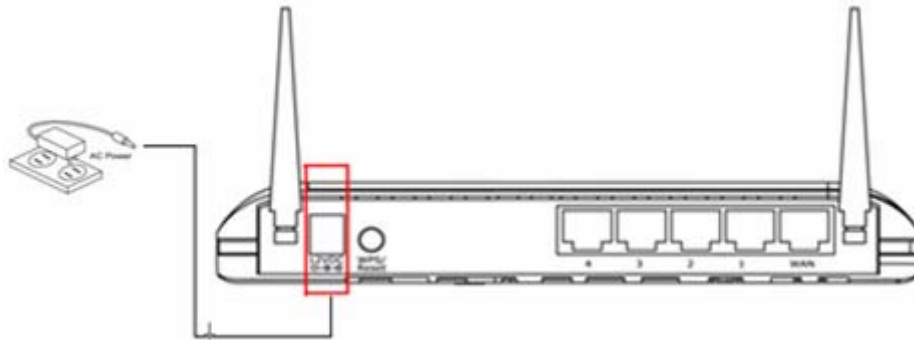

4. Please check all LEDs on the front panel. 'PWR' LED should be steadily on, WAN and LAN LEDs should be on if the computer / network device connected to the respective port of the router is powered on and correctly connected. If PWD LED is not on, or any LED you expected is not on, please recheck the cabling.

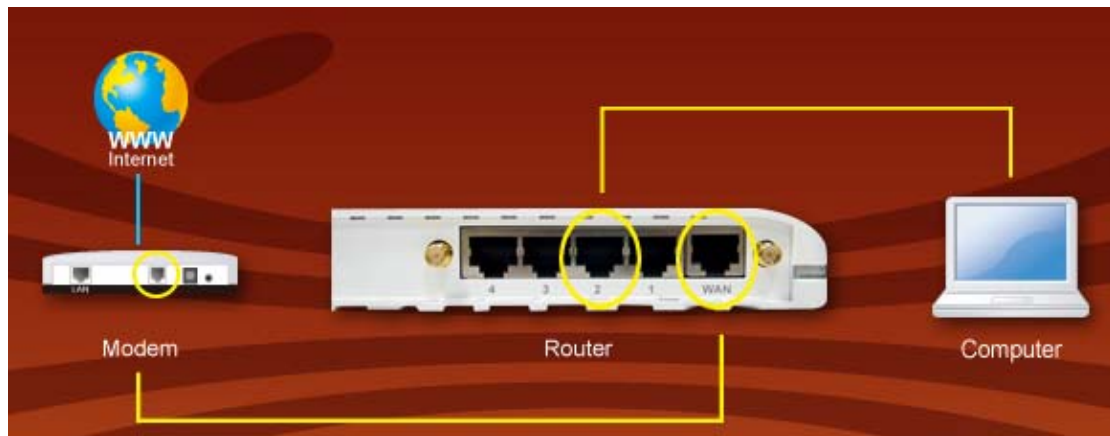

5. To improve wireless signal reception, please arrange the antennas as the picture shown below (horizontal or vertical installation), and place the wireless access point in open space. Please keep the distance between antennas, if the antennas are too close to each other, wireless signal reception will be affected.



## 2-2 Setup client computers to obtain IP address automatically

After the network connection is established, the next step you should do is setup the router with proper network parameters, so it can work properly in your network environment.

Before you can connect to the router and start configuration procedures, your computer must be able to get an IP address automatically (use dynamic IP address). If it's set to use static IP address, or you're unsure, please follow the following instructions to configure your computer to use dynamic IP address:

*If the operating system of your computer is....*

<b>Windows 95/98/Me</b>	<b>- please go to section 2-2-1</b>
<b>Windows 2000</b>	<b>- please go to section 2-2-2</b>
<b>Windows XP</b>	<b>- please go to section 2-2-3</b>
<b>Windows NT</b>	<b>- please go to section 2-2-4</b>

## 2-2-1 Windows 95/98/Me IP address setup:

1. Click 'Start' button (it should be located at lower-left corner of your computer), then click control panel. Double-click **Network** icon, and **Network** window will appear. Select 'TCP/IP', then click 'Properties'.

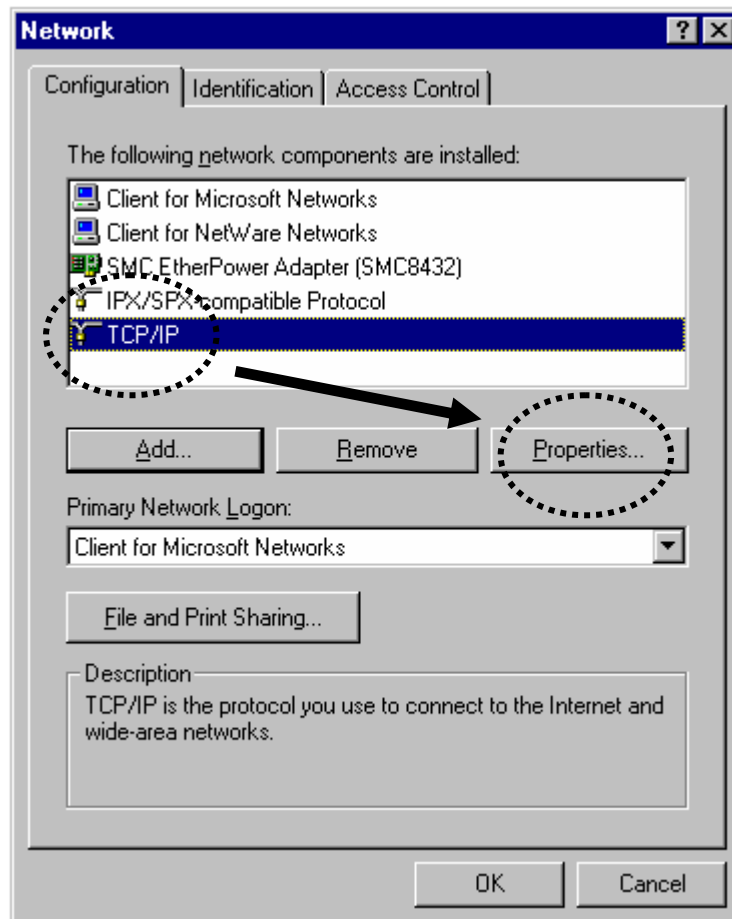

2. Select 'Obtain an IP address from a DHCP server', then click 'OK'.

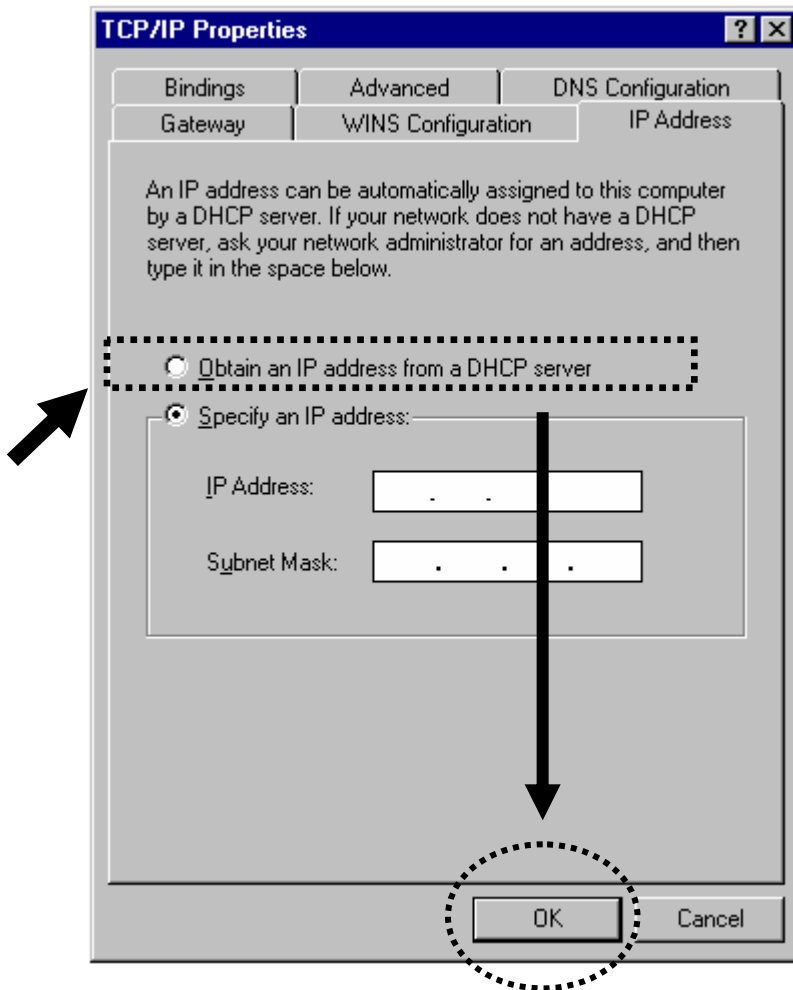

## 2-2-2 Windows 2000 IP address setup:

1. Click 'Start' button (it should be located at lower-left corner of your computer), then click control panel. Double-click **Network and Dial-up Connections** icon, double click **Local Area Connection**, and **Local Area Connection Properties** window will appear. Select 'Internet Protocol (TCP/IP)', then click 'Properties'

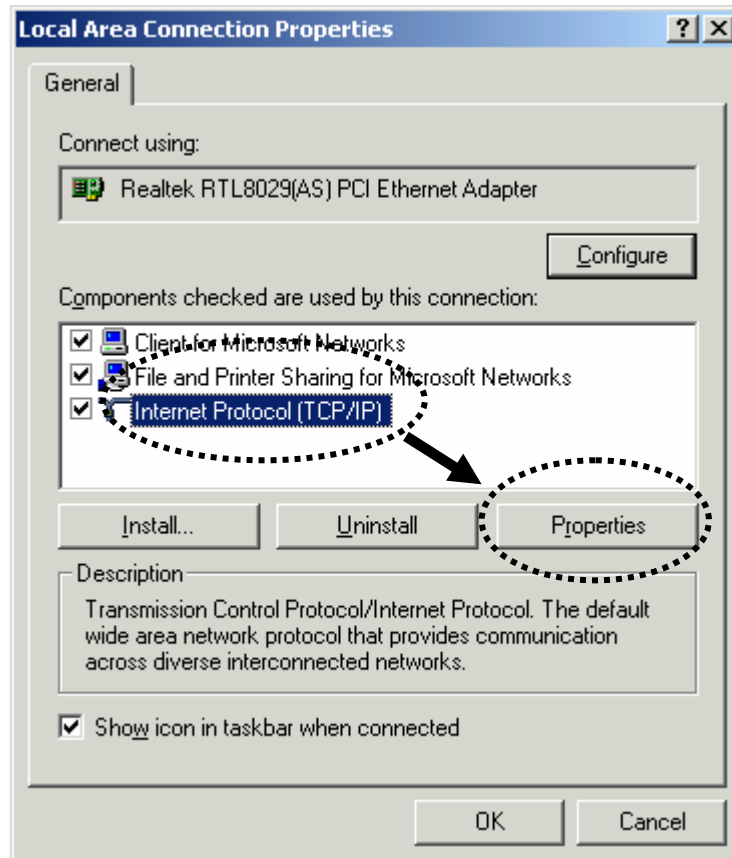

2. Select 'Obtain an IP address automatically' and 'Obtain DNS server address automatically', then click 'OK'.

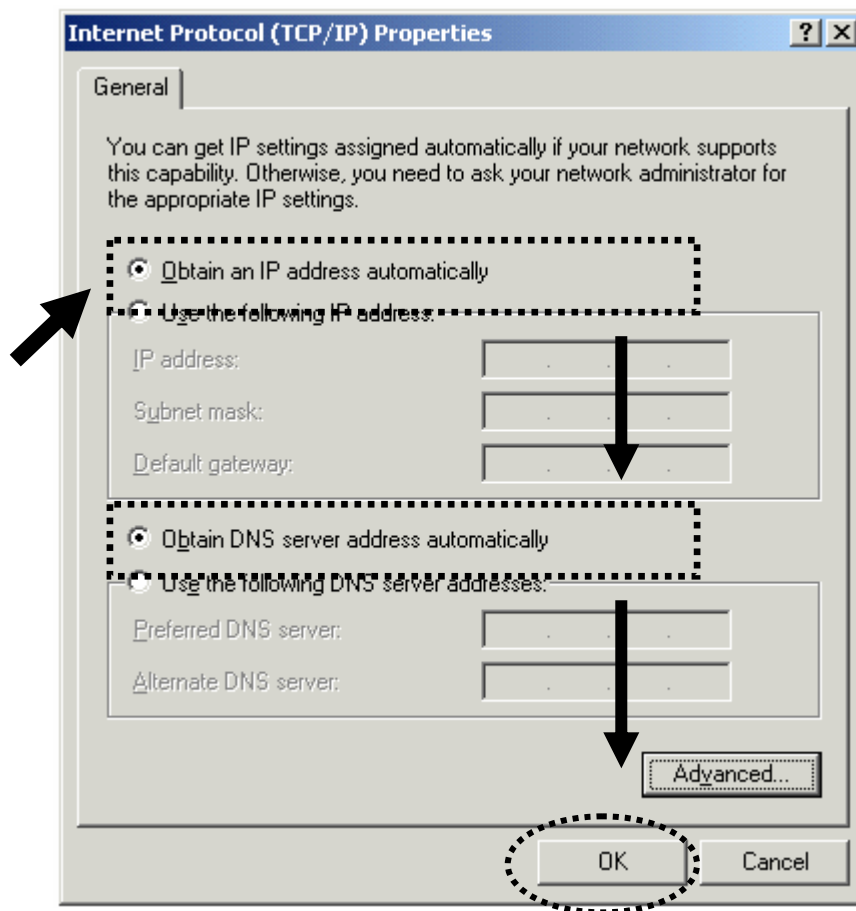

### 2-2-3 Windows XP IP address setup:

1. Click 'Start' button (it should be located at lower-left corner of your computer), then click control panel. Double-click **Network and Internet Connections** icon, click **Network Connections**, then double-click **Local Area Connection**, **Local Area Connection Status** window will appear, and then click 'Properties'

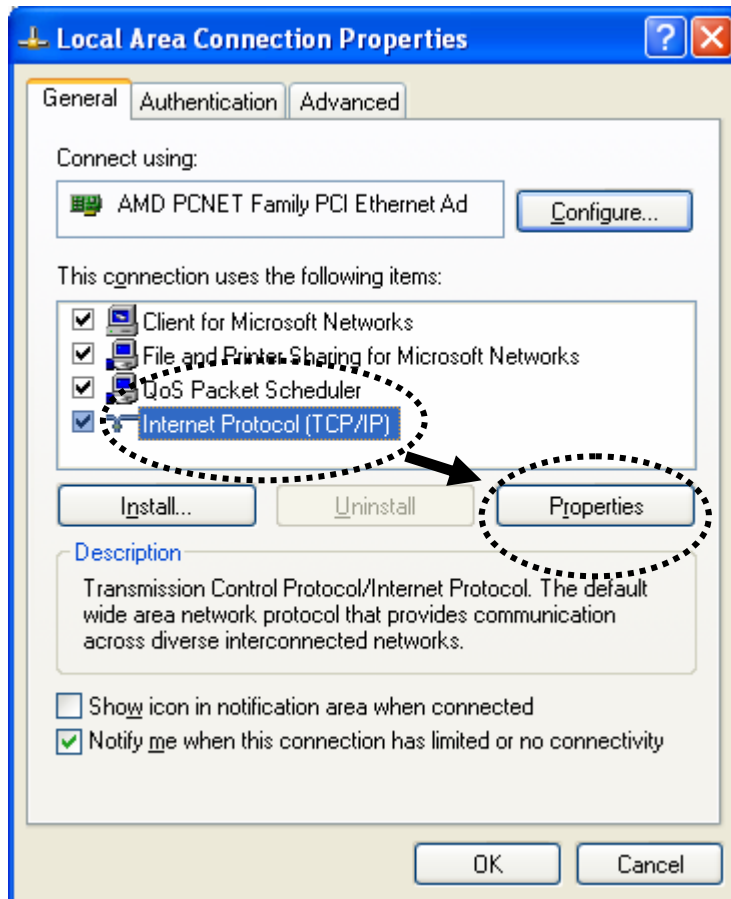

2. Select 'Obtain an IP address automatically' and 'Obtain DNS server address automatically', then click 'OK'.

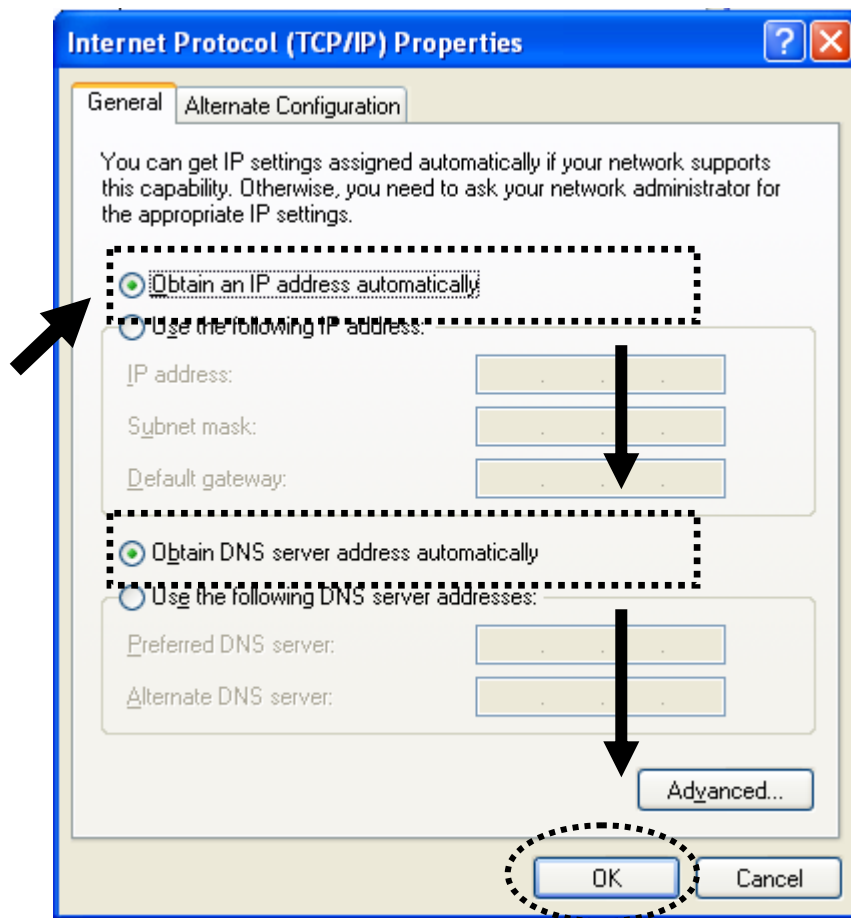

## 2-2-4 Windows Vista IP address setup:

1. Click 'Start' button (it should be located at lower-left corner of your computer), then click control panel. Click **View Network Status and Tasks**, then click **Manage Network Connections**..Right-click **Local Area Netwrok**, then select '**Properties**'. **Local Area Connection Properties** window will appear, select 'Internet Protocol Version 4 (TCP / IPv4), and then click 'Properties'

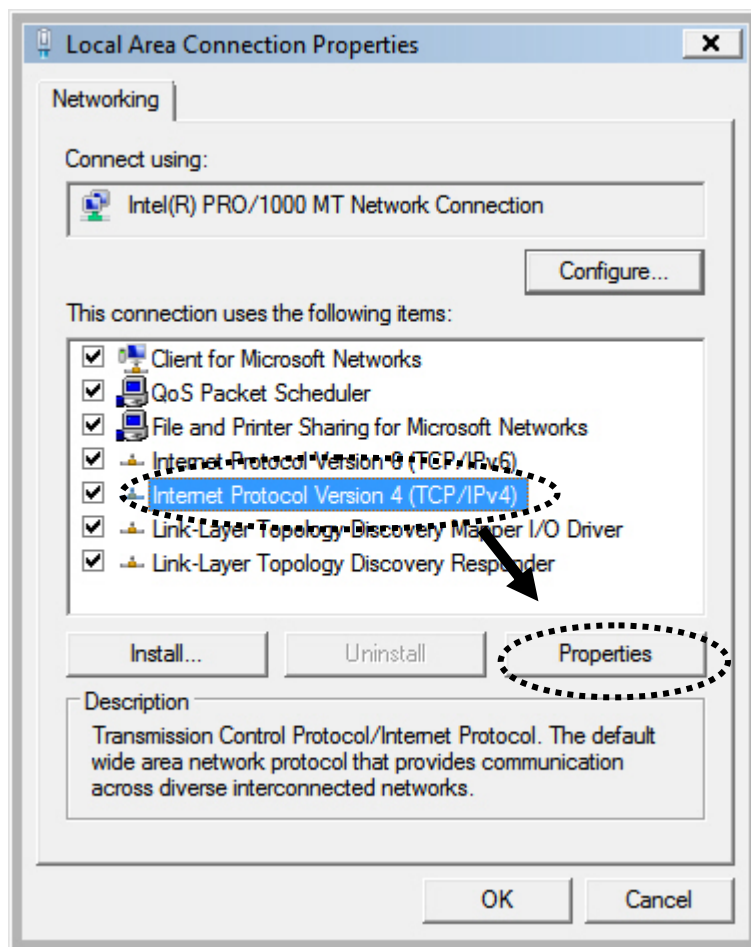

2. Select 'Obtain an IP address automatically' and 'Obtain DNS server address automatically', then click 'OK'.

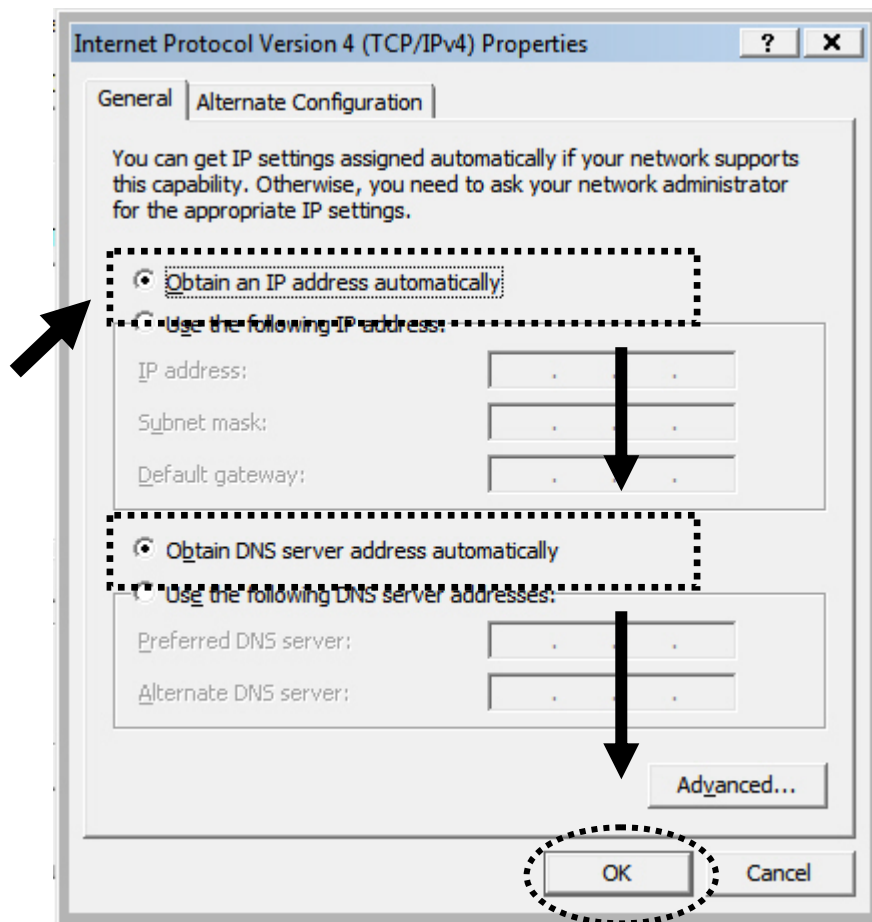

## 2-3 Connect to broadband router by web browser

Default IP address of this broadband router is '192.168.2.1', and you can connect to broadband router's web-based configuration interface by any connected computer with web browser (Internet Explorer 5.x or above, Firefox, or Netscape).

Please input '192.168.2.1' in web browser's address bar and press 'Enter' key to establish connection:

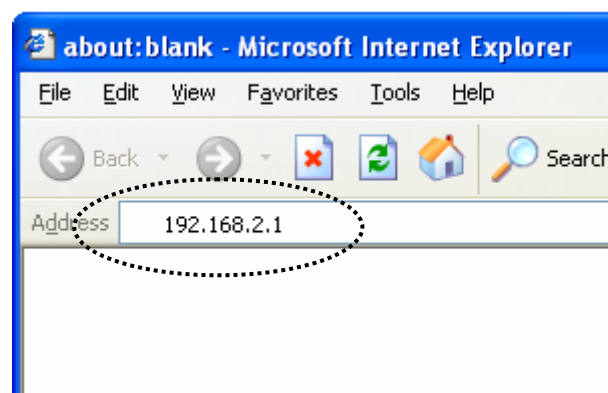

You should see the following authentication window:



Please input 'admin' in 'User name' field, and '1234' in 'Password' field, and click 'OK' button to enter web configuration interface.

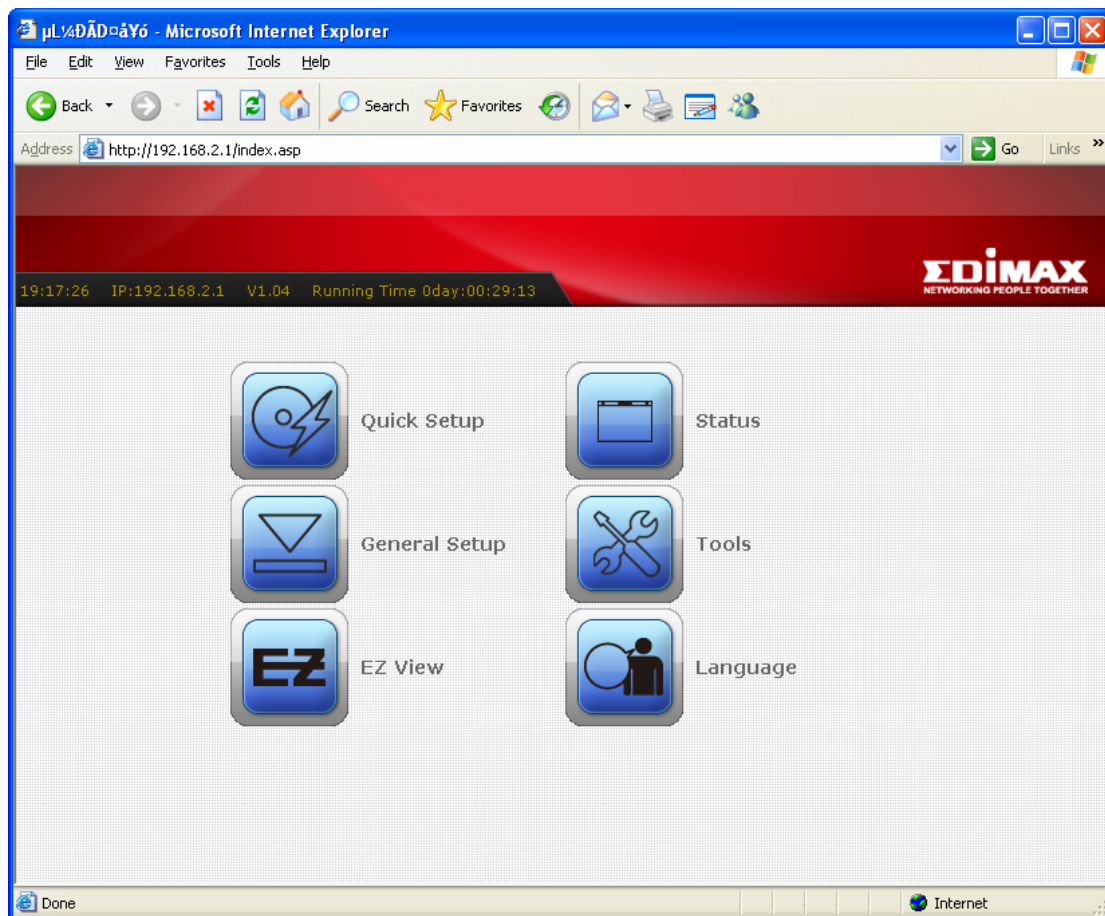

**TIPS:** If you can't establish connection with broadband router with web browser (got 'The page cannot be displayed' or similar error message), the IP address you inputted may be wrong. If you've changed the IP address of this broadband router previously, please input correct IP address instead of the default IP address '192.168.2.1'.

If the DHCP server function of this broadband router is enabled, please follow the following instructions to find out the IP address of this broadband router:

Please click 'start' -> 'run' at the bottom-lower corner of your desktop:



Input 'cmd', then click 'OK'

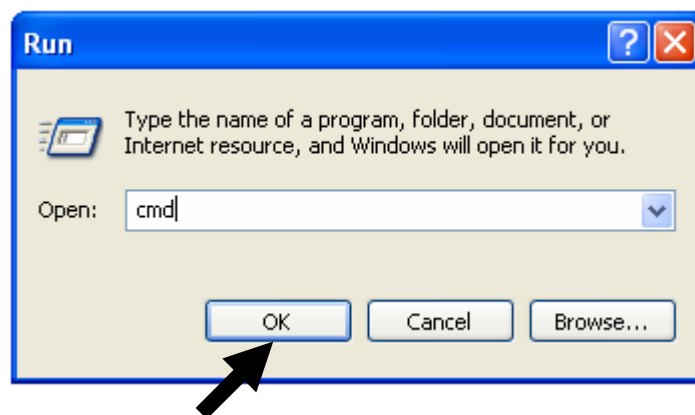

Input 'ipconfig', then press 'Enter' key. Please check the IP address followed by 'Default Gateway' (In this example, the IP address of router is 192.168.2.1, *please note that this value may be different.*)

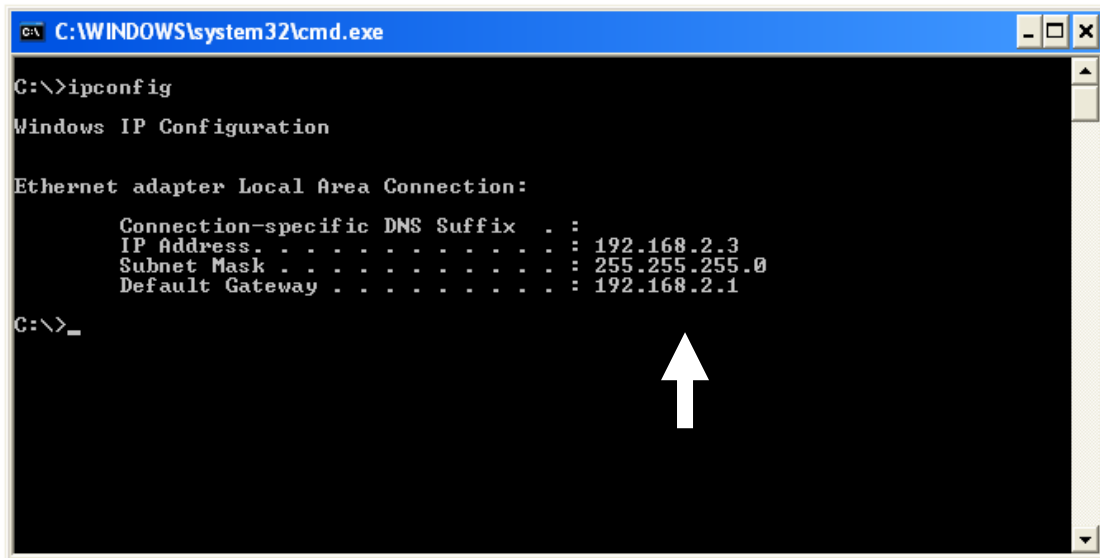

```
C:\WINDOWS\system32\cmd.exe
C:\>ipconfig

Windows IP Configuration

Ethernet adapter Local Area Connection:

    Connection-specific DNS Suffix  . : 
    IP Address. . . . .               : 192.168.2.3
    Subnet Mask . . . . .             : 255.255.255.0
    Default Gateway . . . . .         : 192.168.2.1

C:\>_
```

**NOTE: If the IP address of Gateway is not displayed, or the address followed by 'IP Address' begins with '169', please recheck network connection between your computer and router, and / or go to the beginning of this chapter, to recheck every step of network setup procedure.**

If you tried the instructions listed above and still can not find the IP address of this broadband router / you forget the password, please jump to chapter 3-6-1 to reset the broadband router.

## 2-4 Using 'Quick Setup'

This broadband router provides a 'Quick Setup' menu, and you can setup basic parameters of this broadband router.

Please follow the following instructions to use 'Quick Setup' menu:

1. Click 'Quick Setup' after logged in.

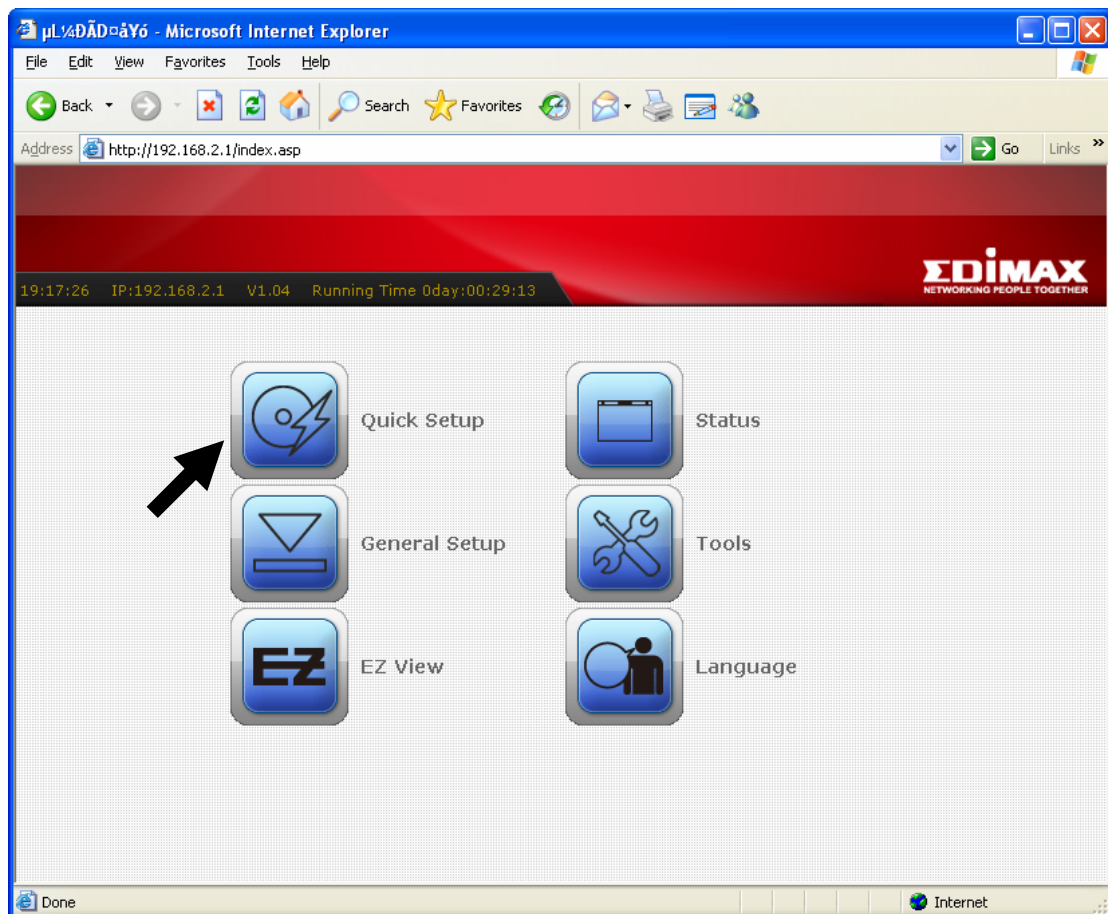

- In the first step of quick setup, you can setup automatic time synchronization settings.

The descriptions of every setting items are listed as follow:

Item Name	Description
Time Zone	Please select a time zone of the country or region of your residence here. If you can't find the country / region of your residence here, please select a city / region which time zone is the same with the country / region of your residence.
Time Server Address	This load-balance router supports NTP (Network Time Protocol). NTP server will provide correct time for this router to setup the date and time of the router automatically. Please input the host name or IP address of NTP server here. If you don't know the host name or IP address of time server, please ask network administrator or use 'pool.ntp.org' as time server.
Daylight Savings	If the country / region of your residence use daylight saving time, please check 'Enable Function' box, and select the beginning and ending date of daylight time saving.

After you finish with time zone settings, please click 'Next' to proceed to next step of quick setup - broadband type:

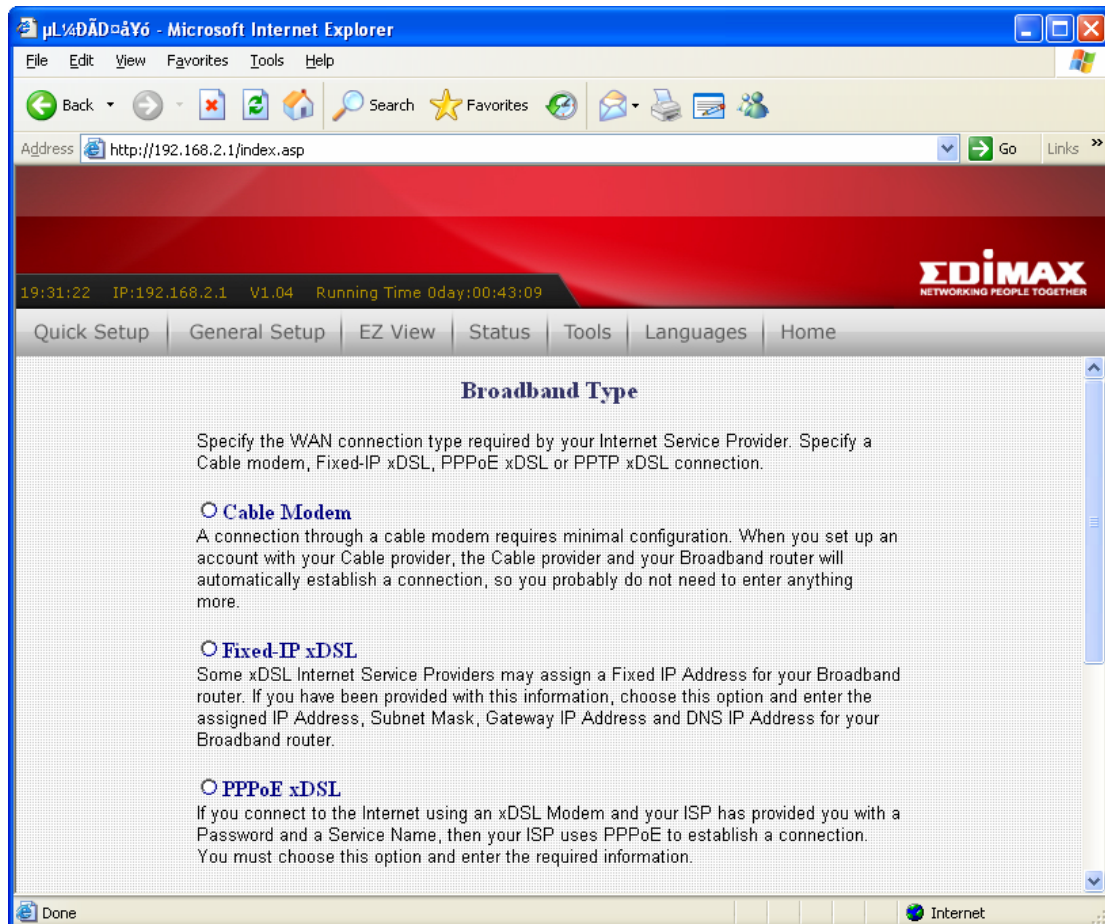

Please choose the broadband (Internet connection) type you're using in this page. There are six types of Internet connection, they are:

- |                  |                              |
|------------------|------------------------------|
| Cable Modem      | - Please go to section 2-4-1 |
| Fixed-IP xDSL    | - Please go to section 2-4-2 |
| PPPoE xDSL       | - Please go to section 2-4-3 |
| PPTP xDSL        | - Please go to section 2-4-4 |
| L2TP xDSL        | - Please go to section 2-4-5 |
| Telstra Big Pond | - Please go to section 2-4-6 |

If you're not sure, please contact your Internet service provider. A wrong Internet connection type will cause connection problem, and you will not be able to connect to internet.

If you want to go back to previous step, please press 'Back' button on the bottom of this page.

**NOTE: Some service providers use 'DHCP' (Dynamic Host Configuration Protocol) to assign IP address to you. In this case, you can choose 'Cable Modem' as Internet connection type, even you're using another connection type, like xDSL. Also, some cable modem uses PPPoE, so you can choose 'PPPoE xDSL' for such cable modem connection, even you're using a cable modem.**

## 2-4-1 Using 'Cable Modem' as broadband connection type

If your Internet service provider uses cable modem to provide Internet service to you, you can select this connection type. You can also select this connection type if your ISP tells you that they will assign you the IP address by 'DHCP' (Dynamic Host Configuration Protocol).

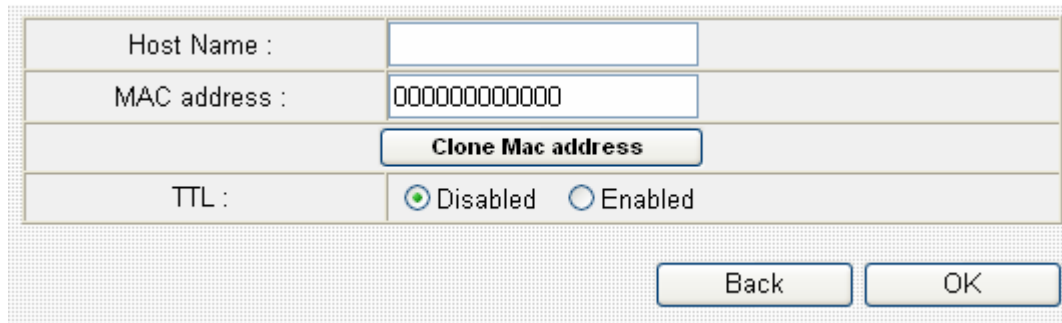

The screenshot shows a network configuration window with the following elements:

- Host Name :** An empty text input field.
- MAC address :** A text input field containing "000000000000". Below it is a button labeled "Clone Mac address".
- TTL :** Two radio buttons: "Disabled" (which is selected) and "Enabled".
- Buttons:** "Back" and "OK" buttons are located at the bottom right of the window.

Here are descriptions of every setup items:

Item Name	Description
<i>Host Name</i>	<i>Please input the host name of your computer, this is optional, and only required if your service provider asks you to do so.</i>
<i>MAC address</i>	<i>Please input MAC address of your computer here, if your service provider only permits computer with certain MAC address to access internet. If you're using the computer which used to connect to Internet via cable modem, you can simply press 'Clone Mac address' button to fill the MAC address field with the MAC address of your computer.</i>
<i>TTL</i>	<i>Time-to-live (TTL) is a value in an Internet Protocol packet that tells a network router whether or not the packet has been in the network too long and should be discarded.</i>

If you wish to select another connection type as broadband connection type, click 'Back'; or you can click 'OK' to finish with quick setup. You'll see the following messages:

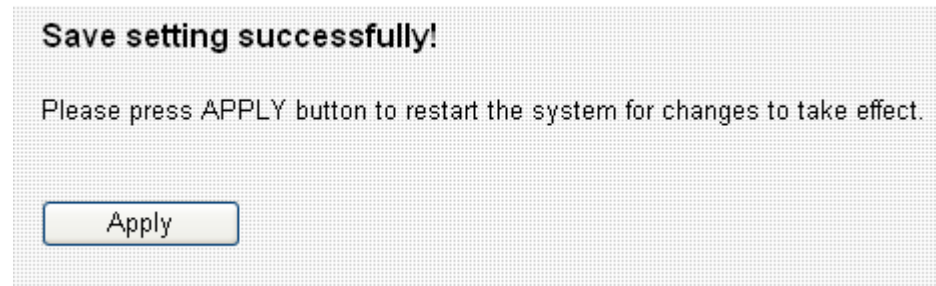

Please click 'Apply' to save changes you made and restart the broadband router, this requires about 30 seconds and the broadband router will stop responding (this is normal and is not malfunction). You can reconnect to this broadband router and continue on other settings later.

## 2-4-2 Using 'Fixed-IP xDSL' as broadband connection type

If your ISP requires you to set a fixed IP address to establish connection, you can use this connection type to input the IP address information assigned by your ISP.

Please note that not only xDSL connections (like ADSL, HDSL, VDSL) can use this connection type, you can select this connection type for all connections that requires you to input a fixed IP address. Also, if your ISP is assigning a fixed IP address to you by DHCP or PPPoE, do not select this connection type. Please contact your ISP's service hotline to make sure you really need to use static IP as connection type.

IP address assigned by your Service Provider :	<input type="text" value="172.1.1.1"/>
Subnet Mask :	<input type="text" value="255.255.0.0"/>
DNS address :	<input type="text"/>
Service Provider Gateway Address :	<input type="text" value="172.1.1.254"/>
TTL :	<input checked="" type="radio"/> Disabled <input type="radio"/> Enabled

Here are descriptions of every setup items:

Item Name	Description
<i>IP address assigned by your by your service provider</i>	<i>Please input IP address assigned by your service provider.</i>
<i>Subnet Mask</i>	<i>Please input subnet mask assigned by your service provider.</i>
<i>DNS address</i>	<i>Please input the IP address of DNS server provided by your service provider.</i>
<i>Service Provider Gateway Address</i>	<i>Please input the IP address of DNS server provided by your service provider.</i>
<i>TTL</i>	<i>Time-to-live (TTL) is a value in an Internet Protocol packet that tells a network router whether or not the packet has been in the network too long and should be discarded.</i>

**You must use the addresses provided by your Internet service provider, wrong setting value will cause connection problem.**

If you wish to select another connection type as broadband connection type, click 'Back'; or you can click 'OK' to finish with quick setup. You'll see the following messages:

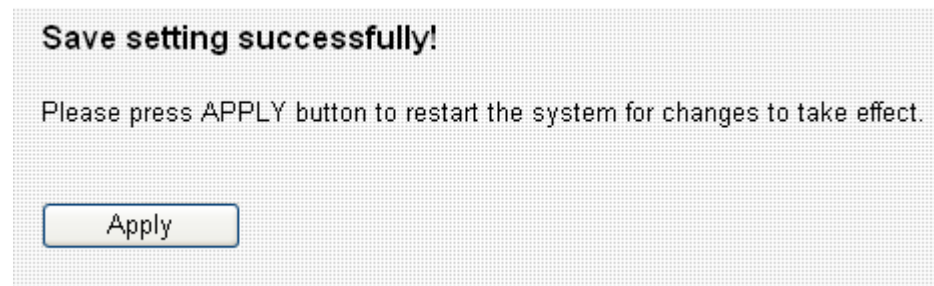

Please click 'Apply' to save changes you made and restart the broadband router, this requires about 30 seconds and the broadband router will stop responding (this is normal and is not malfunction). You can reconnect to this broadband router and continue on other settings later.

### 2-4-3 Using 'PPPoE xDSL' as broadband connection type

If your ISP requires you to establish Internet connection by PPPoE (Point-to-Point Protocol over Ethernet), you can use this connection type to establish Internet connection.

Use PPPoE Authentication	
User Name :	<input type="text"/>
Password :	<input type="password"/>
Service Name :	<input type="text"/>
MTU :	<input type="text" value="1392"/> (512<=MTU Value<=1492)
Connection Type :	<input type="button" value="Continuous"/> <input type="button" value="Connect"/> <input type="button" value="Disconnect"/>
Idle Time Out :	<input type="text" value="10"/> (1-1000 minutes)
TTL :	<input checked="" type="radio"/> Disabled <input type="radio"/> Enabled

Here are descriptions of every setup items:

Item Name	Description
<i>User Name</i>	<i>Please input user name assigned by your Internet service provider here.</i>
<i>Password</i>	<i>Please input the password assigned by your Internet service provider here.</i>
<i>Service Name</i>	<i>Please give a name to this Internet service, this is optional.</i>
<i>MTU</i>	<i>Please input the MTU value of your network connection here. If you don't know, you can use default value.</i>
<i>Connection Type</i>	<i>Please select the connection type of Internet connection you wish to use. There are 3 options:</i>  <i>'Continuous' - keep internet connection alive, do not disconnect.</i>  <i>'Connect on Demand' - only connects to</i>

	<i>Internet when there's a connect attempt,  Manual - only connects to Internet when 'Connect' button on this page is pressed, and disconnects when 'Disconnect button is pressed.</i>
<i>Idle Time Out</i>	<i>Please specify the time to shutdown internet connect after no internet activity is detected in minute(s). This option is only available when connection type is 'Connect on Demand'.</i>
<i>TTL</i>	<i>Time-to-live (TTL) is a value in an Internet Protocol packet that tells a network router whether or not the packet has been in the network too long and should be discarded.</i>

If you wish to select another connection type as broadband connection type, click 'Back'; or you can click 'OK' to finish with quick setup. You'll see the following messages:

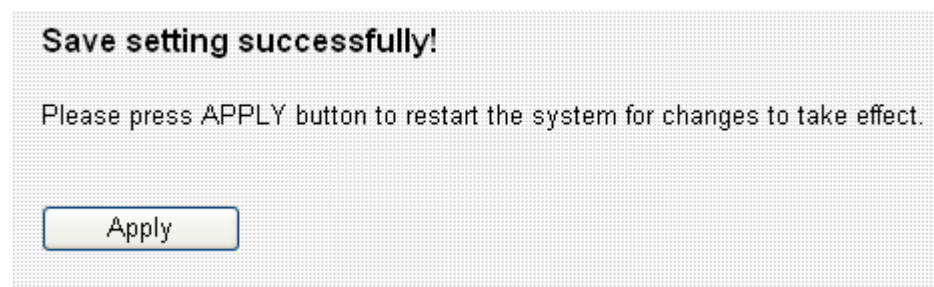

Please click 'Apply' to save changes you made and restart the broadband router, this requires about 30 seconds and the broadband router will stop responding (this is normal and is not malfunction). You can reconnect to this broadband router and continue on other settings later.

## 2-4-4 Using 'PPTP xDSL' as broadband connection type

If your ISP requires you to use PPTP (Point-to-Point Tunneling Protocol) to establish connection, you can select this connection type to establish Internet connection.

PPTP xDSL requires two kinds of setting: WAN interface setting (setup IP address) and PPTP setting (PPTP user name and password). Here we start from WAN interface setting first:

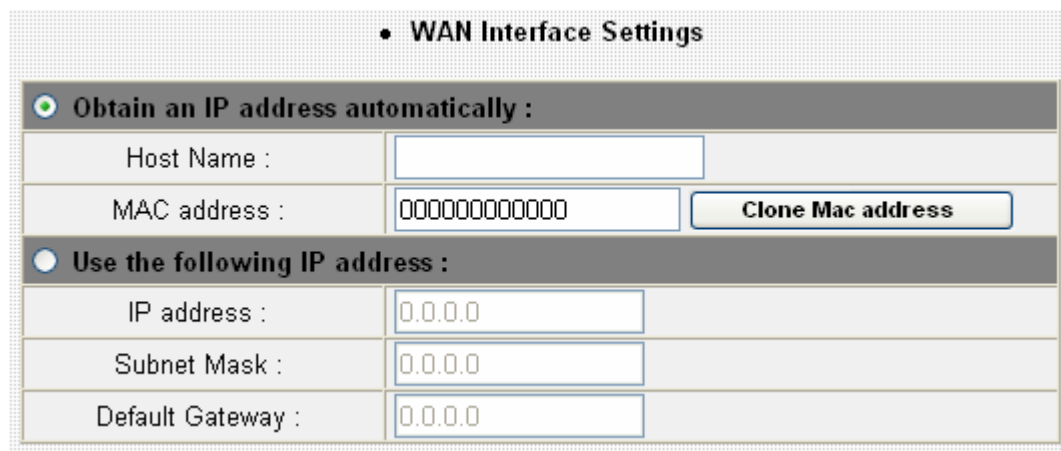

The screenshot shows a configuration window titled "WAN Interface Settings". It contains two main sections for IP address acquisition:

- Obtain an IP address automatically :** This section is currently selected with a radio button. It includes:
  - Host Name : [Empty text box]
  - MAC address : [000000000000] [Clone Mac address button]
- Use the following IP address :** This section is unselected. It includes:
  - IP address : [0.0.0.0]
  - Subnet Mask : [0.0.0.0]
  - Default Gateway : [0.0.0.0]

Select the type of how you obtain IP address from your service provider here. You can choose 'Obtain an IP address automatically' (equal to DHCP, please refer to 'Cable Modem' section above), or 'Use the following IP address' (i.e. static IP address).

WAN interface settings must be correctly set, or the Internet connection will fail even those settings of PPTP settings are correct. Please contact your Internet service provider if you don't know what you should fill in these fields.

Now please go to PPTP settings section:

**• PPTP Settings**

User ID :	<input type="text"/>
Password :	<input type="password"/>
PPTP Gateway :	<input type="text" value="0.0.0.0"/>
Connection ID :	<input type="text"/> (Optional)
MTU :	<input type="text" value="1392"/> (512<=MTU Value<=1492)
BEZEQ-ISRAEL :	<input type="checkbox"/> Enable (for BEZEQ network in ISRAEL use only)
Connection Type :	<input type="text" value="Continuous"/> <input type="button" value="Connect"/> <input type="button" value="Disconnect"/>
Idle Time Out :	<input type="text" value="10"/> (1-1000 minutes)

Here are descriptions of every setup items:

Item Name	Description
<i>User ID</i>	<i>Please input user ID (user name) assigned by your Internet service provider here.</i>
<i>Password</i>	<i>Please input the password assigned by your Internet service provider here.</i>
<i>PPTP Gateway</i>	<i>Please input the IP address of PPTP gateway assigned by your Internet service provider here.</i>
<i>Connection ID</i>	<i>Please input the connection ID here, this is optional and you can leave it blank.</i>
<i>MTU</i>	<i>Please input the MTU value of your network connection here. If you don't know, you can use default value.</i>
<i>BEZEQ-ISRAEL</i>	<i>Check 'Enable' box if you're using BEZEQ network service in Israel. Do not check this box if you're using other Internet service provider.</i>
<i>Connection Type</i>	<i>Please select the connection type of Internet connection you wish to use. There are 3 options:</i>

	<p><i>'Continuous' - keep internet connection alive, do not disconnect.</i></p> <p><i>'Connect on Demand' - only connects to Internet when there's a connect attempt,</i></p> <p><i>Manual - only connects to Internet when 'Connect' button on this page is pressed, and disconnects when 'Disconnect button is pressed.</i></p>
<p><i>Idle Time Out</i></p>	<p><i>Please specify the time to shutdown internet connect after no internet activity is detected in minute(s). This option is only available when connection type is 'Connect on Demand'.</i></p>

If you wish to select another connection type as broadband connection type, click 'Back'; or you can click 'OK' to finish with quick setup. You'll see the following messages:

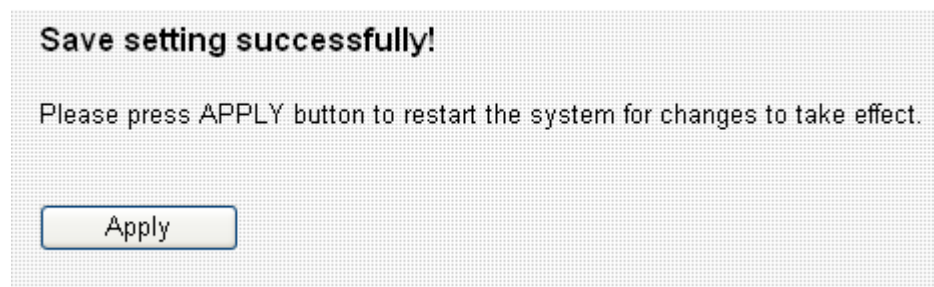

Please click 'Apply' to save changes you made and restart the broadband router, this requires about 30 seconds and the broadband router will stop responding (this is normal and is not malfunction). You can reconnect to this broadband router and continue on other settings later.

## 2-4-5 Using 'L2TP xDSL' as broadband connection type

If your ISP requires you to use L2TP (Layer-2 Tunneling Protocol) to establish connection, you can select this connection type to establish Internet connection. L2TP is another popular connection method for xDSL and other Internet connection types, and all required setting items are the same with PPTP connection.

Like PPTP, there are two kinds of required setting, we'll start from 'WAN Interface Settings':

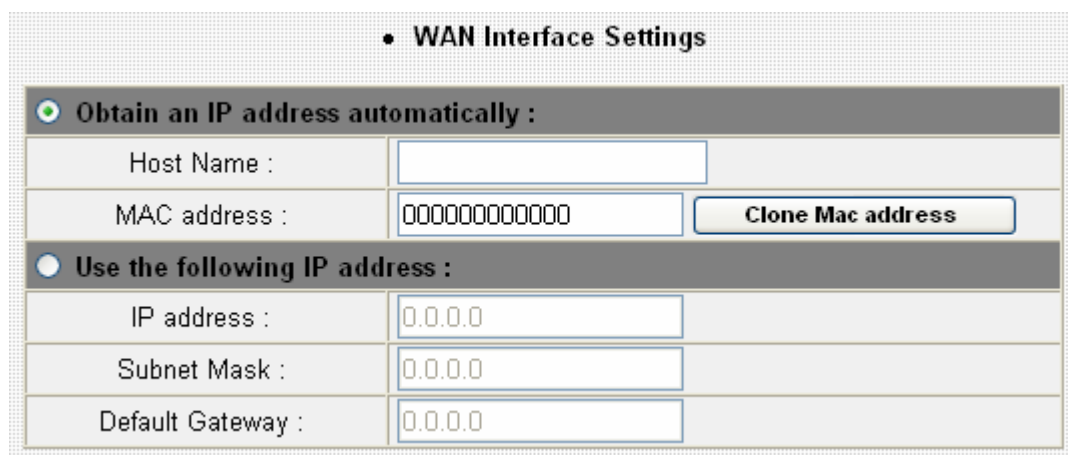

The screenshot shows a configuration window titled "WAN Interface Settings". It contains two main sections for IP address acquisition:

- Obtain an IP address automatically :** This section is currently selected with a radio button. It includes:
  - Host Name : [Empty text box]
  - MAC address : [000000000000] [Clone Mac address button]
- Use the following IP address :** This section is unselected. It includes:
  - IP address : [0.0.0.0]
  - Subnet Mask : [0.0.0.0]
  - Default Gateway : [0.0.0.0]

Please select the type of how you obtain IP address from your service provider here. You can choose 'Obtain an IP address automatically' (equal to DHCP, please refer to 'Cable Modem' section above), or 'Use the following IP address' (equal to static IP address, please refer to 'PPPoE xDSL' section above).

WAN interface settings must be correctly set, or the Internet connection will fail even those settings of L2TP settings are correct. Please contact your Internet service provider if you don't know what you should fill in these fields.

Now please go to L2TP settings section:

**• L2TP Settings**

User ID :	<input type="text"/>
Password :	<input type="password"/>
L2TP Gateway :	<input type="text"/>
MTU :	<input type="text" value="0"/> (512<=MTU Value<=1492)
Connection Type :	<input type="text" value="Continuous"/> <input type="button" value="Connect"/> <input type="button" value="Disconnect"/>
Idle Time Out :	<input type="text" value="0"/> (1-1000 minutes)

Here are descriptions of every setup items:

Item Name	Description
<i>User ID</i>	<i>Please input user ID (user name) assigned by your Internet service provider here.</i>
<i>Password</i>	<i>Please input the password assigned by your Internet service provider here.</i>
<i>L2TP Gateway</i>	<i>Please input the IP address of L2TP gateway assigned by your Internet service provider here.</i>
<i>MTU</i>	<i>Please input the MTU value of your network connection here. If you don't know, you can use default value.</i>
<i>Connection Type</i>	<p><i>Please select the connection type of Internet connection you wish to use. There are 3 options:</i></p> <p><i>'Continuous' - keep internet connection alive, do not disconnect.</i></p> <p><i>'Connect on Demand' - only connects to Internet when there's a connect attempt,</i></p> <p><i>Manual - only connects to Internet when 'Connect' button on this page is pressed, and disconnects when 'Disconnect button is pressed.</i></p>

<i>Idle Time Out</i>	<i>Please specify the time to shutdown internet connect after no internet activity is detected in minute(s). This option is only available when connection type is 'Connect on Demand'.</i>
----------------------	---------------------------------------------------------------------------------------------------------------------------------------------------------------------------------------------

If you wish to select another connection type as broadband connection type, click 'Back'; or you can click 'OK' to finish with quick setup. You'll see the following messages:

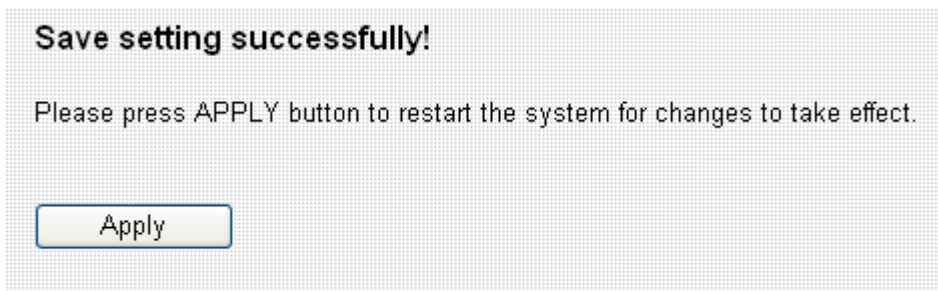

Please click 'Apply' to save changes you made and restart the broadband router, this requires about 30 seconds and the broadband router will stop responding (this is normal and is not malfunction). You can reconnect to this broadband router and continue on other settings later.

## 2-4-6 Using 'Telstra Big Pond' as broadband connection type

This connection type only works for Telstra big pond network service in Australia. DO NOT select this connection type if you're not using Telstra big pond network service.

**Telstra Big Pond (Australia Only)**  
If your Internet service is provided by Telstra Big Pond in Australia, you will need to enter your information below, This information is provided by Teistra BigPond.

User Name :	<input type="text"/>
Password :	<input type="password"/>
<input type="checkbox"/> User decide login server manually	
Login Server :	<input type="text" value="0.0.0.0"/>

Here are descriptions of every setup items:

Item Name	Description
<i>User Name</i>	<i>Please input the user name assigned by Telstra.</i>
<i>Password</i>	<i>Please input the password assigned by Telstra.</i>
<i>User device login server manually</i>	<i>Check this box to choose login server by yourself.</i>
<i>Login Server</i>	<i>Please input the IP address of login server here.</i>

If you wish to select another connection type as broadband connection type, click 'Back'; or you can click 'OK' to finish with quick setup. You'll see the following messages:

**Save setting successfully!**

Please press APPLY button to restart the system for changes to take effect.

Please click 'Apply' to save changes you made and restart the broadband router, this requires about 30 seconds and the broadband router will stop responding (this is normal and is not malfunction). You can reconnect to this broadband router and continue on other settings later.

## Chapter III: General Setup

The ‘General Setup’ is for you to setup “System, WAN, LAN, Wireless, and others ( Advance settings ) “.

Please follow the following instructions to use ‘General Setup’ menu:

1. Click ‘General Setup’ after logged in.



2. Five submenus will appear:

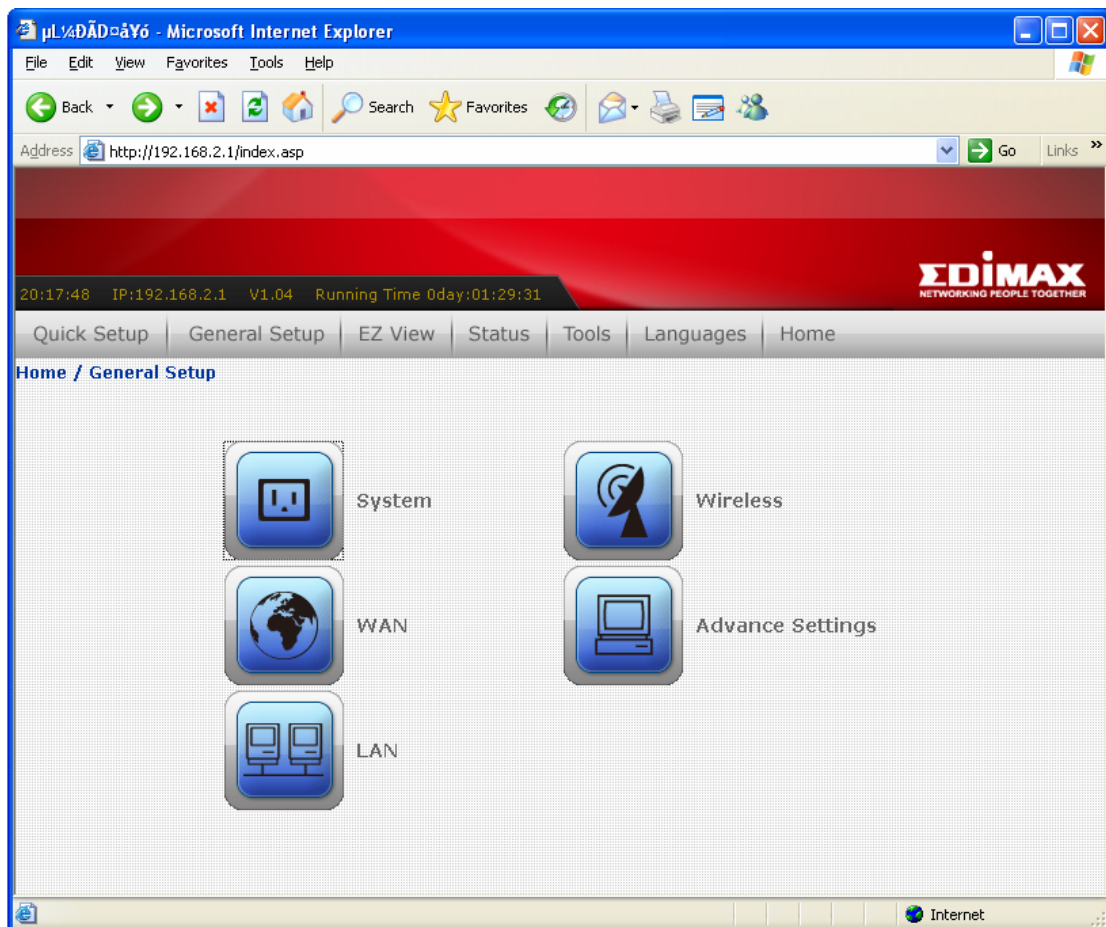

System - Basic system settings (please go to chapter 3-1)

WAN - Setup WAN port manually (please go to chapter 3-2)

LAN - Setup LAN port manually (please go to chapter 3-3)

Wireless - Setup wireless interface manually (please go to chapter 3-4)

Advance Settings - Setup advanced settings of this broadband router  
(Please go to chapter 3-5)

## 3-1 System

You can setup basic system settings of this broadband router in 'System' menu:

<input checked="" type="radio"/>	<b>Time Zone</b>	Set the time zone of the Broadband router. This information is used for log entries and firewall settings.
<input type="radio"/>	<b>Password Settings</b>	You can change the password required to log into the broadband router's system web-based management. By default, the password is 1234. So please assign a password to the Administrator as soon as possible, and store it in a safe place. Passwords can contain 0 to 30 alphanumeric characters, and are case sensitive.
<input type="radio"/>	<b>Remote Management</b>	The remote management function allows you to designate a host in the Internet to have management/configuration access to the Broadband router from a remote site. Enter the designated host IP Address in the Host IP Address field.

Please select the setting item you wish to set, then click 'Apply' button to proceed. You can also click 'Previous' button to back to 'System' menu.

### 3-1-1 Time Zone

You can change the time zone settings of this broadband router. It's important to have correct date and time setting if you need to read system log and use build-in firewall functions.

<b>Set Time Zone :</b>	(GMT)Greenwich Mean Time: Dublin, Edinburgh, Lisbon, London <input type="button" value="v"/>
<b>Time Server Address :</b>	<input type="text" value="192.43.244.18"/>
<b>Daylight Savings :</b>	<input type="checkbox"/> Enable Function Times From <input type="text" value="January"/> <input type="text" value="1"/> To <input type="text" value="January"/> <input type="text" value="1"/>

The descriptions of every setting item are listed as follow:

Item Name	Description
Time Zone	Please select a time zone of the country or region of your residence here. If you can't find the country / region of your residence here, please select a city / region which time zone is the same with the country / region of your residence.
Time Server Address	This load-balance router supports NTP (Network Time Protocol). NTP server will provide correct time for this router to setup the date and time of the router automatically. Please input the host name or IP address of NTP server here. If you don't know the host name or IP address of time server, please ask network administrator or use 'pool.ntp.org' as time server.
Daylight Savings	If the country / region of your residence use daylight saving time, please check 'Enable Function' box, and select the beginning and ending date of daylight time saving.

### 3-1-2 Password Settings

You can change the web login password of this broadband router. If you keep using the default password '1234', other people may access the configuration interface without your permission. Please change the password as soon as possible.

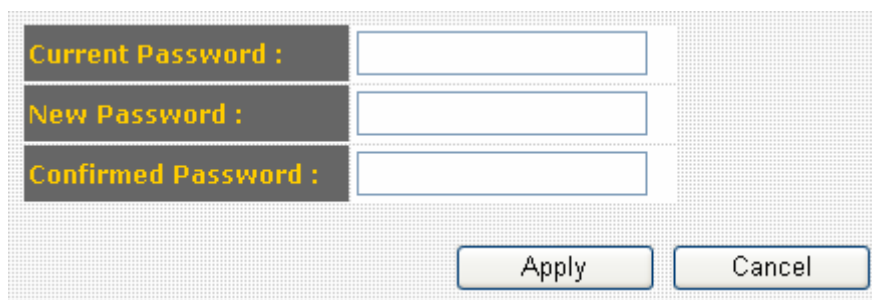

The image shows a web form for password settings. It consists of three rows, each with a label on the left and an input field on the right. The labels are 'Current Password', 'New Password', and 'Confirmed Password'. Below the input fields are two buttons: 'Apply' and 'Cancel'.

The descriptions of every setting item are listed as follow:

Item Name	Description
<i>Current Password</i>	<i>Please input current password here.</i>
<i>New Password</i>	<i>Please input new password here.</i>
<i>Confirmed Password</i>	<i>Please input new password here again for confirmation.</i>

After you inputted current and new password, click 'Apply' to save changes, or you can click 'Cancel' to keep current password untouched.

### 3-1-3 Remote Management

If you need to manage this broadband router outside of your LAN (i.e. from Internet), you can use this function to assign a remote IP address which is permitted to connect to this broadband router's web management interface from Internet.

If it's not required for you to manage this broadband router from Internet, you can disable this function to improve security.

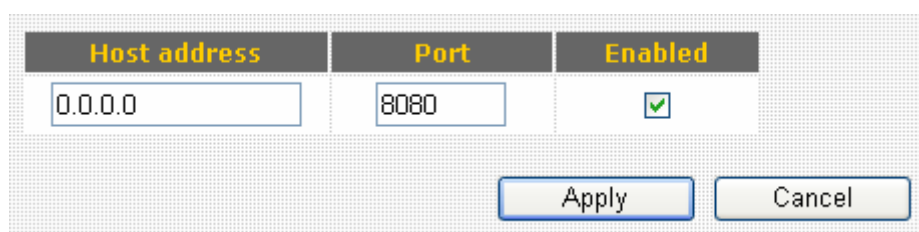

Host address	Port	Enabled
<input type="text" value="0.0.0.0"/>	<input type="text" value="8080"/>	<input checked="" type="checkbox"/>

The descriptions of every setting item are listed as follow:

Item Name	Description
Host address	<i>Input the IP address of the remote host you wish to initiate a management access.</i>
Port	<i>You can define the port number this router should expect an incoming connection request. If you're providing a web service (default port number is 80), you should try to use other port number. You can use the default port setting '8080', or something like '32245' or '1429'. (Any integer between 1 and 65534)</i>
Enabled	<i>Check this box to enable remote management function. When this box is unchecked, no one can access this broadband router's management interface from Internet.</i>

Please click 'Apply' to save changes in this page, or you can click 'Cancel' to discard all settings in this page. After you click 'Apply' button, you'll see the following message:

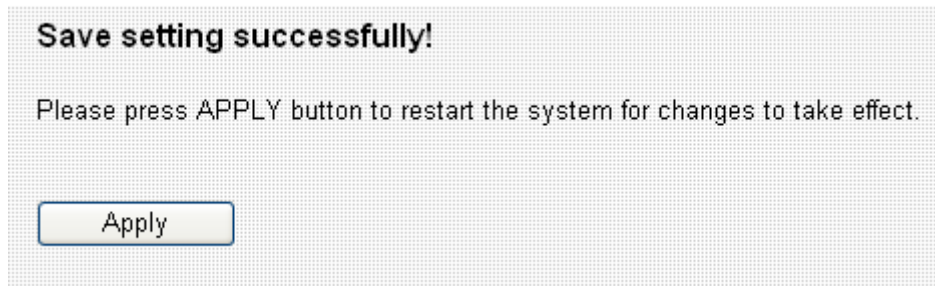

Please click 'Apply' to save changes you made and restart the broadband router, this requires about 30 seconds and the broadband router will stop responding (this is normal and is not malfunction). You can reconnect to this broadband router and continue on other settings later.

## 3-2 WAN

You can setup WAN (Wide Area Network, i.e. Internet) connections of this broadband router in 'WAN' menu:

<input type="radio"/>	<b>Dynamic IP</b>	The Host Name is optional, but may be required by some Service Providers. The default MAC Address is set to the WAN physical interface on the Broadband router. If required by your Service Provider, you can use the 'Clone MAC Address' button to copy the MAC Address of the Network Interface Card installed in your PC and replace the WAN MAC Address with this MAC Address.
<input type="radio"/>	<b>Static IP</b>	If your Service Provider has assigned a Fixed IP address; enter the assigned IP Address, Subnet Mask and the Gateway IP Address provided.
<input type="radio"/>	<b>PPPoE</b>	Enter the PPPoE User Name and Password assigned by your Service Provider. The Service Name is normally optional, but may be required by some Service Providers. Enter a Idle Time (in minutes) to define a maximum period of time for which the Internet connection is maintained during inactivity. If the connection is inactive for longer than the Maximum Idle Time, then the connection will be dropped. You can enable the Connect on Demand option to automatically re-establish the connection as soon as you attempt to access the Internet again. If your Internet Service Provider requires the use of PPPoE, enter the information below.
<input type="radio"/>	<b>PPTP</b>	Point-to-Point Tunneling Protocol is a common connection method used in xDSL connections.
<input type="radio"/>	<b>L2TP</b>	Layer Two Tunneling Protocol is a common connection method used in xDSL connections.
<input type="radio"/>	<b>Telstra Big Pond</b>	If your Internet service is provided by Telstra Big Pond in Australia, you will need to enter your information below, This information is provided by Teistra BigPond.

[Previous](#) [Apply](#)

Please select the WAN connection type you wish to use, then click 'Apply' to continue. You can also click 'Previous' to back to previous page.

If you're not sure which connection type you should use, please call your ISP's service hotline and ask for help. You'll not be able to connect to Internet with wrong connection type.

### 3-2-1 Dynamic IP

Dynamic IP means your ISP will assign an IP address to you automatically by 'DHCP' (Dynamic Host Configuration Protocol). Dynamic IP is often used by cable modem Internet connection.

The screenshot shows a network configuration window with the following elements:

- Host Name :** An empty text input field.
- MAC address :** A text input field containing the value "000000000000".
- Clone Mac address**: A button located below the MAC address field.
- TTL :** Two radio button options: "Disabled" (which is selected) and "Enabled".
- Back** and **OK**: Two buttons at the bottom right of the window.

Here are descriptions of every setup items:

Item Name	Description
<i>Host Name</i>	<i>Please input the host name of your computer, this is optional, and only required if your service provider asks you to do so.</i>
<i>MAC address</i>	<i>Please input MAC address of your computer here, if your service provider only permits computer with certain MAC address to access internet. If you're using the computer which used to connect to Internet via cable modem, you can simply press 'Clone Mac address' button to fill the MAC address field with the MAC address of your computer.</i>
<i>TTL</i>	<i>Time-to-live (TTL) is a value in an Internet Protocol packet that tells a network router whether or not the packet has been in the network too long and should be discarded.</i>

If you wish to select another connection type as broadband connection type, click 'Back'; or you can click 'OK' to finish with quick setup. You'll see the following messages:

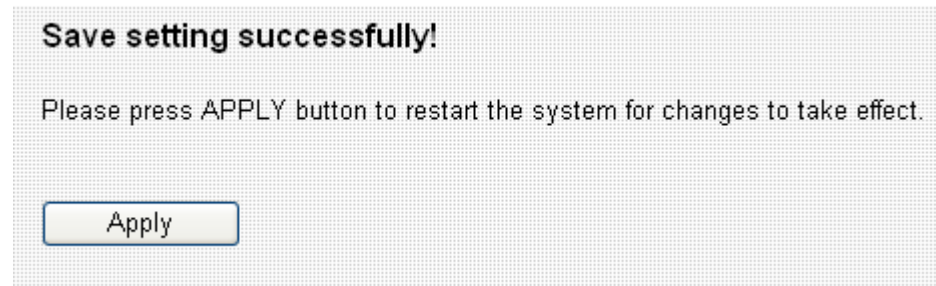

Please click 'Apply' to save changes you made and restart the broadband router, this requires about 30 seconds and the broadband router will stop responding (this is normal and is not malfunction). You can reconnect to this broadband router and continue on other settings later.

### 3-2-2 Static IP

Some ISP will give you a fixed IP address, and ask you to use this IP address to establish Internet connection. In this case, you have to select this connection type to establish connection with your ISP.

Please note that if your ISP is assigning a fixed IP address to you by DHCP or PPPoE, do not select this connection type. Please contact your ISP's service hotline to make sure you really need to use static IP as connection type.

IP address assigned by your Service Provider :	<input type="text" value="172.1.1.1"/>
Subnet Mask :	<input type="text" value="255.255.0.0"/>
DNS address :	<input type="text"/>
Service Provider Gateway Address :	<input type="text" value="172.1.1.254"/>
TTL :	<input checked="" type="radio"/> Disabled <input type="radio"/> Enabled

Here are descriptions of every setup items:

Item Name	Description
<i>IP address assigned by your by your service provider</i>	<i>Please input IP address assigned by your service provider.</i>
<i>Subnet Mask</i>	<i>Please input subnet mask assigned by your service provider.</i>
<i>DNS address</i>	<i>Please input the IP address of DNS server provided by your service provider.</i>
<i>Service Provider Gateway Address</i>	<i>Please input the IP address of DNS server provided by your service provider.</i>
<i>TTL</i>	<i>Time-to-live (TTL) is a value in an Internet Protocol packet that tells a network router whether or not the packet has been in the network too long and should be discarded.</i>

**You must use the addresses provided by your Internet service provider, wrong setting value will cause connection problem.**

If you wish to select another connection type as broadband connection type, click 'Back'; or you can click 'OK' to finish with quick setup. You'll see the following messages:

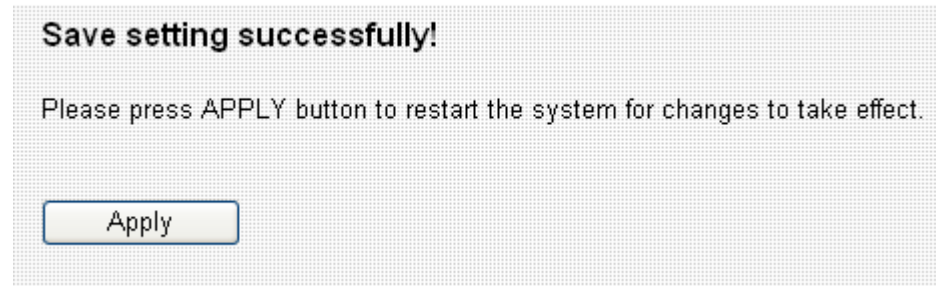

Please click 'Apply' to save changes you made and restart the broadband router, this requires about 30 seconds and the broadband router will stop responding (this is normal and is not malfunction). You can reconnect to this broadband router and continue on other settings later.

### 3-2-3 PPPoE

If your ISP requires you to establish Internet connection by PPPoE (Point-to-Point Protocol over Ethernet), you can use this connection type to establish Internet connection.

Use PPPoE Authentication	
User Name :	<input type="text"/>
Password :	<input type="password"/>
Service Name :	<input type="text"/>
MTU :	<input type="text" value="1392"/> (512<=MTU Value<=1492)
Connection Type :	<input type="button" value="Continuous"/> <input type="button" value="Connect"/> <input type="button" value="Disconnect"/>
Idle Time Out :	<input type="text" value="10"/> (1-1000 minutes)
TTL :	<input checked="" type="radio"/> Disabled <input type="radio"/> Enabled

Here are descriptions of every setup items:

Item Name	Description
<i>User Name</i>	<i>Please input user name assigned by your Internet service provider here.</i>
<i>Password</i>	<i>Please input the password assigned by your Internet service provider here.</i>
<i>Service Name</i>	<i>Please give a name to this Internet service, this is optional.</i>
<i>MTU</i>	<i>Please input the MTU value of your network connection here. If you don't know, you can use default value.</i>
<i>Connection Type</i>	<i>Please select the connection type of Internet connection you wish to use. There are 3 options:</i>  <i>'Continuous' - keep internet connection alive, do not disconnect.</i>  <i>'Connect on Demand' - only connects to</i>

	<p><i>Internet when there's a connect attempt,</i></p> <p><i>Manual - only connects to Internet when 'Connect' button on this page is pressed, and disconnects when 'Disconnect button is pressed.</i></p>
<i>Idle Time Out</i>	<p><i>Please specify the time to shutdown internet connect after no internet activity is detected in minute(s). This option is only available when connection type is 'Connect on Demand'.</i></p>
<i>TTL</i>	<p><i>Time-to-live (TTL) is a value in an Internet Protocol packet that tells a network router whether or not the packet has been in the network too long and should be discarded.</i></p>

If you wish to select another connection type as broadband connection type, click 'Back'; or you can click 'OK' to finish with quick setup. You'll see the following messages:

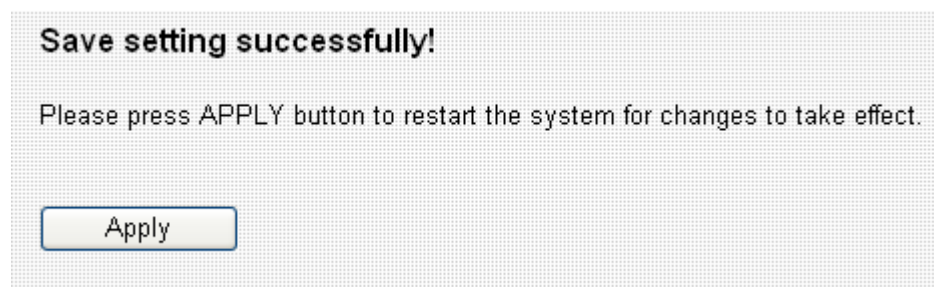

Please click 'Apply' to save changes you made and restart the broadband router, this requires about 30 seconds and the broadband router will stop responding (this is normal and is not malfunction). You can reconnect to this broadband router and continue on other settings later.

### 3-2-4 PPTP

If your ISP requires you to use PPTP (Point-to-Point Tunneling Protocol) to establish connection, you can select this connection type to establish Internet connection.

PPTP requires two kinds of setting: WAN interface setting (setup IP address) and PPTP setting (PPTP user name and password). Here we start from WAN interface setting first:

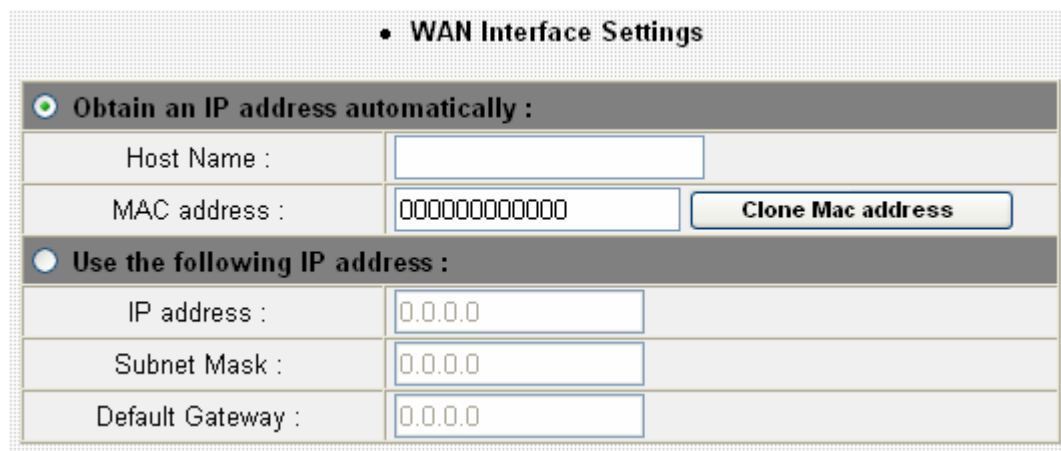

The screenshot shows a configuration window titled "WAN Interface Settings". It contains two main sections for IP address acquisition:

- Obtain an IP address automatically :** This section is currently selected with a radio button. It includes:
  - Host Name : [Empty text box]
  - MAC address : [000000000000] [Clone Mac address button]
- Use the following IP address :** This section is unselected. It includes:
  - IP address : [0.0.0.0]
  - Subnet Mask : [0.0.0.0]
  - Default Gateway : [0.0.0.0]

Select the type of how you obtain IP address from your service provider here. You can choose 'Obtain an IP address automatically' (equal to DHCP, please refer to 'Cable Modem' section above), or 'Use the following IP address' (i.e. static IP address).

WAN interface settings must be correctly set, or the Internet connection will fail even those settings of PPTP settings are correct. Please contact your Internet service provider if you don't know what you should fill in these fields.

Now please go to PPTP settings section:

**• PPTP Settings**

User ID :	<input type="text"/>
Password :	<input type="password"/>
PPTP Gateway :	<input type="text" value="0.0.0.0"/>
Connection ID :	<input type="text"/> (Optional)
MTU :	<input type="text" value="1392"/> (512<=MTU Value<=1492)
BEZEQ-ISRAEL :	<input type="checkbox"/> Enable (for BEZEQ network in ISRAEL use only)
Connection Type :	<input type="text" value="Continuous"/> <input type="button" value="Connect"/> <input type="button" value="Disconnect"/>
Idle Time Out :	<input type="text" value="10"/> (1-1000 minutes)

Here are descriptions of every setup items:

Item Name	Description
<i>User ID</i>	<i>Please input user ID (user name) assigned by your Internet service provider here.</i>
<i>Password</i>	<i>Please input the password assigned by your Internet service provider here.</i>
<i>PPTP Gateway</i>	<i>Please input the IP address of PPTP gateway assigned by your Internet service provider here.</i>
<i>Connection ID</i>	<i>Please input the connection ID here, this is optional and you can leave it blank.</i>
<i>MTU</i>	<i>Please input the MTU value of your network connection here. If you don't know, you can use default value.</i>
<i>BEZEQ-ISRAEL</i>	<i>Check 'Enable' box if you're using BEZEQ network service in Israel. Do not check this box if you're using other Internet service provider.</i>
<i>Connection Type</i>	<i>Please select the connection type of Internet connection you wish to use. There are 3 options:</i>

	<p><i>'Continuous' - keep internet connection alive, do not disconnect.</i></p> <p><i>'Connect on Demand' - only connects to Internet when there's a connect attempt,</i></p> <p><i>Manual - only connects to Internet when 'Connect' button on this page is pressed, and disconnects when 'Disconnect button is pressed.</i></p>
<p><i>Idle Time Out</i></p>	<p><i>Please specify the time to shutdown internet connect after no internet activity is detected in minute(s). This option is only available when connection type is 'Connect on Demand'.</i></p>

If you wish to select another connection type as broadband connection type, click 'Back'; or you can click 'OK' to finish with quick setup. You'll see the following messages:

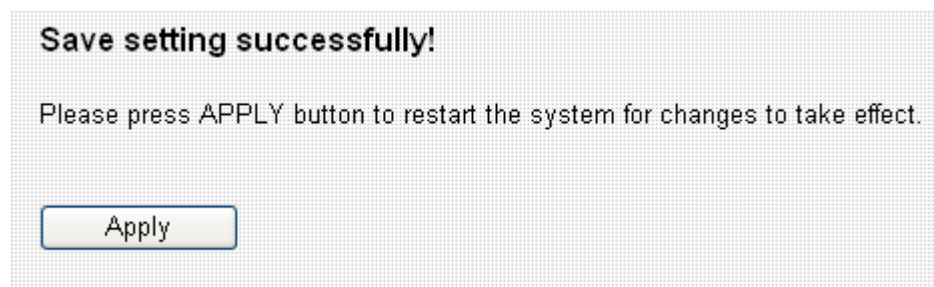

Please click 'Apply' to save changes you made and restart the broadband router, this requires about 30 seconds and the broadband router will stop responding (this is normal and is not malfunction). You can reconnect to this broadband router and continue on other settings later.

### 3-2-5 L2TP

If your ISP requires you to use L2TP (Layer-2 Tunneling Protocol) to establish connection, you can select this connection type to establish Internet connection. L2TP is another popular connection method for xDSL and other Internet connection types, and all required setting items are the same with PPTP connection.

Like PPTP, there are two kinds of required setting, we'll start from 'WAN Interface Settings':

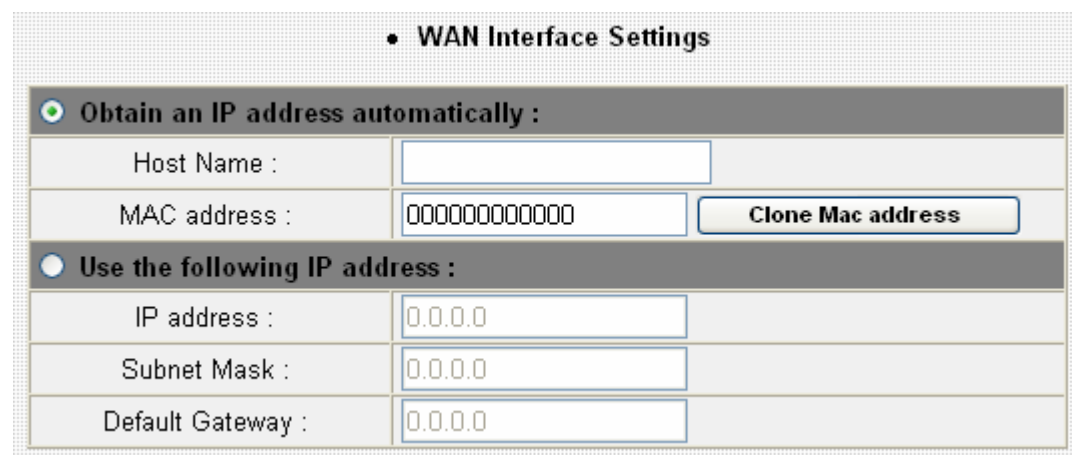

The screenshot shows the 'WAN Interface Settings' configuration page. It features two radio button options for IP address acquisition. The first option, 'Obtain an IP address automatically', is selected. Below it are fields for 'Host Name' (empty), 'MAC address' (000000000000), and a 'Clone Mac address' button. The second option, 'Use the following IP address', is unselected. Below it are fields for 'IP address' (0.0.0.0), 'Subnet Mask' (0.0.0.0), and 'Default Gateway' (0.0.0.0).

• WAN Interface Settings	
<input checked="" type="radio"/> Obtain an IP address automatically :	
Host Name :	<input type="text"/>
MAC address :	<input type="text" value="000000000000"/> <input type="button" value="Clone Mac address"/>
<input type="radio"/> Use the following IP address :	
IP address :	<input type="text" value="0.0.0.0"/>
Subnet Mask :	<input type="text" value="0.0.0.0"/>
Default Gateway :	<input type="text" value="0.0.0.0"/>

Please select the type of how you obtain IP address from your service provider here. You can choose 'Obtain an IP address automatically' (equal to DHCP, please refer to 'Cable Modem' section above), or 'Use the following IP address' (equal to static IP address, please refer to 'PPPoE xDSL' section above).

WAN interface settings must be correctly set, or the Internet connection will fail even those settings of L2TP settings are correct. Please contact your Internet service provider if you don't know what you should fill in these fields.

Now please go to L2TP settings section:

**• L2TP Settings**

User ID :	<input type="text"/>
Password :	<input type="password"/>
L2TP Gateway :	<input type="text"/>
MTU :	<input type="text" value="0"/> (512<=MTU Value<=1492)
Connection Type :	<input type="text" value="Continuous"/> <input type="button" value="Connect"/> <input type="button" value="Disconnect"/>
Idle Time Out :	<input type="text" value="0"/> (1-1000 minutes)

Here are descriptions of every setup items:

Item Name	Description
<i>User ID</i>	<i>Please input user ID (user name) assigned by your Internet service provider here.</i>
<i>Password</i>	<i>Please input the password assigned by your Internet service provider here.</i>
<i>L2TP Gateway</i>	<i>Please input the IP address of L2TP gateway assigned by your Internet service provider here.</i>
<i>MTU</i>	<i>Please input the MTU value of your network connection here. If you don't know, you can use default value.</i>
<i>Connection Type</i>	<p><i>Please select the connection type of Internet connection you wish to use. There are 3 options:</i></p> <p><i>'Continuous' - keep internet connection alive, do not disconnect.</i></p> <p><i>'Connect on Demand' - only connects to Internet when there's a connect attempt,</i></p> <p><i>Manual - only connects to Internet when 'Connect' button on this page is pressed, and disconnects when 'Disconnect button is pressed.</i></p>
<i>Idle Time Out</i>	<i>Please specify the time to shutdown internet</i>

	<i>connect after no internet activity is detected in minute(s). This option is only available when connection type is 'Connect on Demand'.</i>
--	------------------------------------------------------------------------------------------------------------------------------------------------

If you wish to select another connection type as broadband connection type, click 'Back'; or you can click 'OK' to finish with quick setup. You'll see the following messages:

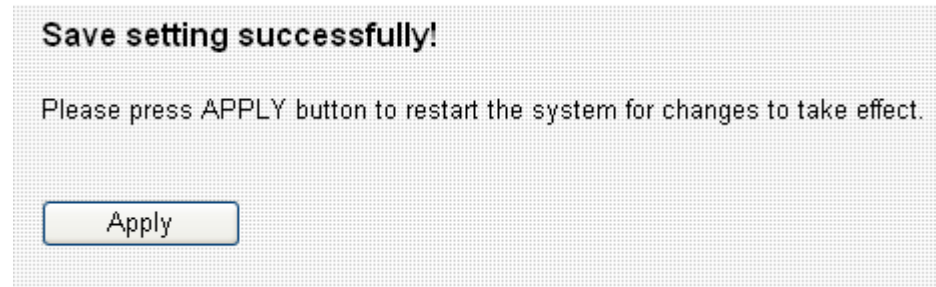

Please click 'Apply' to save changes you made and restart the broadband router, this requires about 30 seconds and the broadband router will stop responding (this is normal and is not malfunction). You can reconnect to this broadband router and continue on other settings later.

### 3-2-6 Telstra Big Pond

This connection type only works for Telstra big pond network service in Australia. DO NOT select this connection type if you're not using Telstra big pond network service.

**Telstra Big Pond (Australia Only)**  
If your Internet service is provided by Telstra Big Pond in Australia, you will need to enter your information below, This information is provided by Teistra BigPond.

User Name :	<input type="text"/>
Password :	<input type="password"/>
<input type="checkbox"/> User decide login server manually	
Login Server :	<input type="text" value="0.0.0.0"/>

Here are descriptions of every setup items:

Item Name	Description
<i>User Name</i>	<i>Please input the user name assigned by Telstra.</i>
<i>Password</i>	<i>Please input the password assigned by Telstra.</i>
<i>User device login server manually</i>	<i>Check this box to choose login server by yourself.</i>
<i>Login Server</i>	<i>Please input the IP address of login server here.</i>

If you wish to select another connection type as broadband connection type, click 'Back'; or you can click 'OK' to finish with quick setup. You'll see the following messages:

**Save setting successfully!**

Please press APPLY button to restart the system for changes to take effect.

Please click 'Apply' to save changes you made and restart the broadband router, this requires about 30 seconds and the broadband router will stop responding (this is normal and is not malfunction). You can reconnect to this broadband router and continue on other settings later.

### 3-3 LAN (Wired)

You can setup Wired LAN (Local Area Network) connections of this broadband router in 'LAN' menu. This broadband router has 4 LAN ports and they'll all use the same LAN IP address settings. Please also note that both wired and wireless LAN uses the same LAN IP address settings, too.

LAN settings split into 3 sections: LAN IP, DHCP Server, and Static DHCP leases. Please refer to corresponding sections below for detailed setup instructions.

#### 3-3-1 Before you start - Suggestions for deciding an IP address to be used with this broadband router

Before all computers using wired Ethernet connection (i.e. those computers connect to this router's LAN port 1 to 4 by Ethernet cable) or wireless connection can communicate with each other and access internet, they must have a valid IP address.

There are two ways to assign IP addresses to computers: static IP address (set the IP address for every computer manually), and dynamic IP address (IP address of computers will be assigned by router automatically. It's recommended for most of computers to use dynamic IP address, it will save a lot of time on setting IP addresses for every computer, especially when there are a lot of computers in your network; for servers and network devices which will provide services to other computer and users that come from Internet, static IP address should be used, so other computers can locate the server.

This broadband router has a built-in DHCP (Dynamic Host Configuration Protocol) server, and can help you to assign IP addresses to your client computers. Almost all network computers / devices manufactured after year 1995 are compatible with DHCP, and you can let this broadband router to assign the IP address to client computers / devices for you.

***Suggestions on IP address numbering plan:***

If you have no idea on how to define an IP address plan for your network, here are some suggestions.

- 1. A valid IP address has 4 fields: a.b.c.d, for most of home and company users, it's suggested to use 192.168.c.d, where c is an integer between 0 and 254, and d is an integer between 1 and 254. This router is capable to work with up to 253 clients, so you can set 'd' field of IP address of router as 1 or 254 (or any number between 1 and 254), and pick a number between 0 and 254 for field 'c'.**
- 2. In most cases, you should use '255.255.255.0' as subnet mask, which allows up to 253 clients (this also meets router's capability of working with up to 253 clients).**
- 3. For all servers and network devices which will provide services to other people (like Internet service, print service, and file service), they should use static IP address. Give each of them a unique number between 1 and 253, and maintain a list, so everyone can locate those servers easily.**
- 4. For computers which are not dedicated to provide specific service to others, they should use dynamic IP address.**

***If you don't really understand the descriptions listed above, don't worry! We will provide recommended setup values below.***

### 3-3-2 LAN IP

You can use this setting to assign an IP address to the LAN interface of this broadband router.

IP address :	<input type="text" value="192.168.2.1"/>
Subnet Mask :	<input type="text" value="255.255.255.0"/>
802.1d Spanning Tree :	<input type="button" value="Disabled"/> ▾
DHCP Server :	<input type="button" value="Enabled"/> ▾
Lease Time :	<input type="button" value="Forever"/> ▾

Here are descriptions of every setup items:

Item Name	Description
<i>IP address</i>	<i>Please input the IP address of this broadband router's LAN interface.</i>
<i>Subnet Mask</i>	<i>Please input subnet mask for this network.</i>
<i>802.1d Spanning Tree</i>	<i>If you wish to activate 802.1d spanning tree function, select 'Enabled' for setup item '802.1d Spanning Tree', or set it to 'Disabled'.</i>
<i>DHCP Server</i>	<i>If you want to activate DHCP server function of this router, select 'Enabled', or set it to 'Disabled'.</i>
<i>Lease Time</i>	<i>Please select the lease time for every DHCP leases here. You can select the time period from the dropdown list, and the DHCP client will be forced to obtain a new IP address from this broadband router after this period of time. You can select 'Forever' if you're using this broadband router with only few computers (less than 30 computers)</i>

**Recommended Value if you don't know what to fill:**

IP Address: 192.168.1.254

Subnet Mask: 255.255.255.0

802.1d Spanning Tree: Disabled

DHCP Server: Enabled

### 3-3-3 DHCP Server

You can use this setting to decide the range of IP address leases.

DHCP Server	
Start IP :	<input type="text" value="192.168.2.100"/>
End IP :	<input type="text" value="192.168.2.200"/>
Domain Name :	<input type="text"/>

Here are descriptions of every setup items:

Item Name	Description
<i>Start IP</i>	<i>Please input the start IP address of the IP leases range.</i>
<i>End IP</i>	<i>Please input the end IP address of the IP leases range.</i>
<i>Domain Name</i>	<i>If you wish, you can also input the domain name for your network. This is optional.</i>

**Recommended Value if you don't know what to fill:**

Lease Time: Two Weeks (or 'Forever', if you have less than 20 computers)  
Start IP: 192.168.1.1  
End IP: 192.168.1.200  
Domain Name: (leave it blank)

**NOTE:**

- 1. The number of the last field (mentioned 'd' field) of 'End IP' must be greater than 'Start IP', and can not the same with router's IP address.**
- 2. The former three fields of IP address of 'Start IP', 'End IP', and 'IP Address of 'LAN IP' section (mentioned 'a', 'b', and 'c' field) should be the same.**
- 3. These settings will affect wireless clients, too.**

### 3-3-4 Static DHCP Leases

If you wish to assign a fixed IP address to certain computers / devices by DHCP, you can use this function to establish a MAC-to-IP address table here, so you can assign a specific IP address to a specific computer / network device by its MAC address.

The screenshot shows a web-based configuration interface for Static DHCP Leases. At the top, it is titled "Static DHCP Leases Table" and includes a note: "It allows to entry 16 sets address only." Below this is a table with four columns: "NO.", "MAC address", "IP address", and "Select". Underneath the table are three buttons: "Delete Selected", "Delete All", and "Reset". A checkbox labeled "Enable Static DHCP Leases" is present. Below the checkbox is a "New" section with two input fields: "MAC address :" and "IP address :". To the right of these fields are "Add" and "Clear" buttons. At the bottom right of the interface are "Apply" and "Cancel" buttons.

Here are descriptions of every setup items:

Item Name	Description
<i>Enable Static DHCP Leases</i>	<i>Check this box to enable this function, otherwise uncheck it to disable this function.</i>
<i>MAC Address</i>	<i>Input the MAC address of the computer or network device (total 12 characters, with character from 0 to 9, and from a to f, like '001122aabbcc').</i>
<i>IP address</i>	<i>Input the IP address you want to assign to this computer or network device.</i>
<i>Add</i>	<i>After you inputted MAC address and IP address pair, click this button to add the pair to static DHCP leases table.</i>
<i>Clear</i>	<i>Click this button to remove texts in MAC address and IP address field.</i>

All MAC-to-IP address entries will be listed in this page, and this broadband router supports up to 16 static DHCP leases:

**Static DHCP Leases Table**  
It allows to entry 16 sets address only.

NO.	MAC address	IP address	Select
1	11:22:33:44:55:66	192.168.2.10	<input type="checkbox"/>
2	aa:bb:cc:dd:ee:ff	192.168.2.11	<input type="checkbox"/>

To delete one or more entries listed here, please check the box of the mapping entry (under 'Select'), and click 'Delete Selected' button.

If you wish to delete all mapping entries, click 'Delete All' button. To deselect all checked boxes, click 'Reset' button.

When you finished with the settings in this page, you can click 'Apply' button to save changes you made in this page, or you can click 'Cancel' to discard changes. After you click 'Apply' button, you'll see the following messages:

**Save setting successfully!**

Please press APPLY button to restart the system for changes to take effect.

Please click 'Apply' to save changes you made and restart the broadband router, this requires about 30 seconds and the broadband router will stop responding (this is normal and is not malfunction). You can reconnect to this broadband router and continue on other settings later.

### 3-4 Wireless

You can setup Wireless LAN connection parameters of this broadband router in 'Wireless' menu:

<input type="radio"/>	<b>Basic Settings</b>	This page allows you to define ESSID, and Channel for the wireless connection. These parameters are used for the wireless stations to connect to the Access Point.
<input type="radio"/>	<b>Security Settings</b>	This page allows you setup the wireless security. Turn on WEP or WPA by using Encryption Keys could prevent any unauthorized access to your wireless network.
<input type="radio"/>	<b>MAC Address Filtering</b>	For security reason, the Access Point features MAC Address Filtering that only allows authorized MAC Addresses associating to the Access Point.
<input type="radio"/>	<b>WPS(Wi-Fi Protected Setup) Settings</b>	This page allows you to change the setting for WPS(Wi-Fi Protected Setup).WPS can help your wireless client automatically connect to the Access Point.

Please select one setting in this menu, then click 'Apply' to proceed. If you wish to go back to previous page, click 'Previous'.

### 3-4-1 Basic Settings

You can set basic settings of wireless LAN here.

Mode :	AP
Band :	2.4 GHz (B+G+N)
ESSID :	default
Channel Number :	11
Associated Clients :	Show Active Clients

Please select the working mode of this broadband router from 'Mode' dropdown list first:

- a. *AP*: Standard wireless AP (access point).
- b. *Station-Infrastructure*: This broadband router acts as both wireless communication client and server - connects to another wireless access point as client, and serves other wireless clients as server.
- c. *AP Bridge-Point to Point*: Connect this router with another broadband router, to expand the scope of network.
- d. *AP Bridge-Point to Multi-Point*: Connect this router with up to four other broadband routers, to expand the scope of network.
- e. *AP Bridge-WDS*: Connect this router with up to four WDS-capable broadband routers, to expand the scope of network.
- f. *Universal Repeater*: This broadband router will repeat other wireless access point's signal to extend its wireless signal coverage, and also acts as a wireless access point to serve other wireless clients.

### 3-4-1-1 AP mode

In AP mode, the following settings will appear:

The screenshot shows a configuration window for AP mode. It contains the following fields and controls:

- Mode :** A dropdown menu with 'AP' selected.
- Band :** A dropdown menu with '2.4 GHz (B+G+N)' selected.
- ESSID :** A text input field containing 'default'.
- Channel Number :** A dropdown menu with '11' selected.
- Associated Clients :** A button labeled 'Show Active Clients'.
- At the bottom right, there are two buttons: 'Apply' and 'Cancel'.

Here are descriptions of every setup items:

Item Name	Description
<i>Band</i>	<p><i>Please select the radio band from one of following options:</i></p> <p><i>2.4 GHz (B): 2.4GHz band, only allows 802.11b wireless network client to connect this router (maximum transfer rate 11Mbps).</i></p> <p><i>2.4 GHz (N): 2.4GHz band, only allows 802.11n wireless network client to connect this router (maximum transfer rate 150Mbps).</i></p> <p><i>2.4 GHz (B+G): 2.4GHz band, only allows 802.11b and 802.11g wireless network client to connect this router (maximum transfer rate 11Mbps for 802.11b clients, and maximum 54Mbps for 802.11g clients).</i></p> <p><i>2.4 GHz (G): 2.4GHz band, only allows 802.11g wireless network client to connect this router (maximum transfer rate 54Mbps).</i></p>

	<p><i>2.4 GHz (B+G+N): 2.4GHz Band, Allows 802.11b, 802.11g, and 802.11N wireless clients. It's recommends to select this band to maximize compatibility.</i></p>
<i>ESSID</i>	<p><i>This is the name of broadband router. You can type any alphanumerical characters here, maximum 32 characters. ESSID is used to identify your own broadband router from others when there are other broadband routers in the same area. Default SSID is 'default', it's recommended to change default ESSID value to the one which is meaningful to you, like myhome, office_room1, etc.</i></p>
<i>Channel Number</i>	<p><i>Please select a channel from the dropdown list of 'Channel Number', available channel numbers are 1 to 13. You can choose any channel number you want to use, and almost all wireless clients can locate the channel you're using automatically without any problem. However, it's still useful to remember the channel number you use, some wireless client supports manual channel number select, and this would help in certain scenario when there is some radio communication problem.</i></p>
<i>Associated Clients</i>	<p><i>Click 'Show Active Clients' button to show the list of all connected wireless clients. You can click 'Refresh' in new window to get latest list again, or click 'Close' to close the window.</i></p> <p><i>Please note that if you have pop-up blocker installed, you may have to disable it or tell your pop-up blocker to allow the popup window, or you will not be able to see the wireless client list window.</i></p>

**TIPS: You can try to change channel number to another one if you think the data transfer rate is too slow, or keep having problem while transferring the file over wireless network. There could be some other broadband routers using the same channel, which will disturb the radio communication between wireless client and the broadband**

When you finished with the settings in this page, you can click ‘Apply’ button to save changes you made in this page, or you can click ‘Cancel’ to discard changes. After you click ‘Apply’ button, you’ll see the following messages:

**Save setting successfully!**

You may press CONTINUE button to continue configuring other settings or press APPLY button to restart the system for changes to take effect

Continue

Apply

Please click ‘Apply’ to save changes you made and restart the broadband router, this requires about 30 seconds and the broadband router will stop responding (this is normal and is not malfunction). You can reconnect to this broadband router and continue on other settings later.

You can click ‘Continue’ to continue on other settings without restart the broadband router, however, the changes you made will not take effect before you restart the broadband router.

### 3-4-1-2 Station-Infrastructure

In Station-Infrastructure mode, you can select a wireless access point to become its wireless client, and also acts as wireless access point to serve other wireless clients. If you have the access privilege of other wireless access point nearby, and you wish to use that access point to access Internet, you can use this connection type:

Mode :	Station-Infrastructure	<input type="button" value="v"/>
Band :	2.4 GHz (B+G+N)	<input type="button" value="v"/>
ESSID :	default	
Site Survey :	<input type="button" value="Select Site Survey"/>	
WLAN MAC :	000C29E03FF3	<input type="button" value="Clone MAC"/>
Auto MAC Clone :	00:0C:43:28:60:50	<input checked="" type="radio"/> Disable <input type="radio"/> Enable
<input type="button" value="Apply"/> <input type="button" value="Cancel"/>		

Here are descriptions of every setup items:

Item Name	Description
<i>Band</i>	<p><i>Please select the radio band from one of following options (must be the same with the wireless access point you wish to connect):</i></p> <p><i>2.4 GHz (B): 2.4GHz band, only allows 802.11b wireless network client to connect this router (maximum transfer rate 11Mbps).</i></p> <p><i>2.4 GHz (N): 2.4GHz band, only allows 802.11n wireless network client to connect this router (maximum transfer rate 150Mbps).</i></p> <p><i>2.4 GHz (B+G): 2.4GHz band, only allows 802.11b and 802.11g wireless network client to connect this router (maximum transfer rate 11Mbps for 802.11b clients, and maximum</i></p>

	<p>54Mbps for 802.11g clients).</p> <p>2.4 GHz (G): 2.4GHz band, only allows 802.11g wireless network client to connect this router (maximum transfer rate 54Mbps).</p> <p>2.4 GHz (B+G+N): 2.4GHz Band, Allows 802.11b, 802.11g, and 802.11N wireless clients. It's recommends to select this band to maximize compatibility.</p>
<p><i>ESSID</i></p>	<p>This is the name of broadband router. You can type any alphanumerical characters here, maximum 32 characters. ESSID is used to identify your own broadband router from others when there are other broadband routers in the same area. Default SSID is 'default', it's recommended to change default ESSID value to the one which is meaningful to you, like myhome, office_room1, etc.</p>
<p><i>Site Survey</i></p>	<p>Click 'Select Site Survey' and a popup window will appear. All reachable wireless access points will be shown in the window. Select the wireless access point you wish to connect from the list, and click 'Done'. If the wireless access point you wish to connect is not listed, you can click 'Refresh' to rescan.</p> <p>If you still can't find the wireless access point you wish to connect, please move the broadband router to the place nearer to the access point you wish to connect.</p>
<p><i>WLAN MAC</i></p>	<p>Some wireless access points will only allow clients with certain MAC address to establish connection. In this case, you can input the MAC address that will be accepted by the wireless access point you wish to connect here. You can also click 'Clone MAC' button to use the MAC address of your</p>

	<i>computer (the one you used to connect to the web management interface currently).</i>
<i>Auto MAC Clone</i>	<i>If you wish to use the MAC address of wired LAN interface of this broadband router, select 'Enable', or select 'Disable' to not to use the MAC address of the wired LAN interface of this broadband router.</i>

When you finished with the settings in this page, you can click 'Apply' button to save changes you made in this page, or you can click 'Cancel' to discard changes. After you click 'Apply' button, you'll see the following messages:

**Save setting successfully!**

You may press CONTINUE button to continue configuring other settings or press APPLY button to restart the system for changes to take effect

Continue

Apply

Please click 'Apply' to save changes you made and restart the broadband router, this requires about 30 seconds and the broadband router will stop responding (this is normal and is not malfunction). You can reconnect to this broadband router and continue on other settings later.

You can click 'Continue' to continue on other settings without restart the broadband router, however, the changes you made will not take effect before you restart the broadband router.

### 3-4-1-3 AP Bridge-Point to Point

In this mode, you can use this broadband router as a wireless network bridge and let all computers connected to the LAN ports of both wireless access points to communicate with each other. **This mode supports only one wireless access point peer.**

Please note that when you select this mode, this broadband router will act as wireless bridge only, and will not accept other wireless clients.

Also, you can connect to the wireless access point with the same functionality only. If you wish to connect to the wireless access points made by other manufacturer, please select 'AP Bridge-WDS' mode if the wireless access point you wish to connect supports WDS.

Mode :	AP Bridge-Point to Point
Band :	2.4 GHz (B+G+N)
Channel Number :	7
MAC address 1 :	000000000000
Set Security :	Set Security

Apply Cancel

Here are descriptions of every setup items:

Item Name	Description
<i>Band</i>	<i>Please select the radio band from one of following options (must be the same with the wireless access point you wish to connect):</i>  <i>2.4 GHz (B): 2.4GHz band, only allows 802.11b wireless network client to connect this router (maximum transfer rate 11Mbps).</i>  <i>2.4 GHz (N): 2.4GHz band, only allows 802.11n wireless network client to connect this</i>

	<p><i>router (maximum transfer rate 150Mbps).</i></p> <p><i>2.4 GHz (B+G): 2.4GHz band, only allows 802.11b and 802.11g wireless network client to connect this router (maximum transfer rate 11Mbps for 802.11b clients, and maximum 54Mbps for 802.11g clients).</i></p> <p><i>2.4 GHz (G): 2.4GHz band, only allows 802.11g wireless network client to connect this router (maximum transfer rate 54Mbps).</i></p> <p><i>2.4 GHz (B+G+N): 2.4GHz Band, Allows 802.11b, 802.11g, and 802.11N wireless clients. It's recommends to select this band to maximize compatibility.</i></p>
<i>Channel Number</i>	<i>Select the channel number you wish to use; both access points must use the same channel.</i>
<i>MAC address 1</i>	<i>Input the MAC address of another wireless access point (the one you wish to connect).</i>
<i>Set Security</i>	<i>Click 'Set Security' button to set security functions of this wireless connection to improve security. Please refer to chapter 3-2-1-7 for detailed instructions.</i>

When you finished with the settings in this page, you can click 'Apply' button to save changes you made in this page, or you can click 'Cancel' to discard changes. After you click 'Apply' button, you'll see the following messages:

**Save setting successfully!**

You may press CONTINUE button to continue configuring other settings or press APPLY button to restart the system for changes to take effect

Continue

Apply

Please click 'Apply' to save changes you made and restart the broadband router, this requires about 30 seconds and the broadband router will stop responding (this is normal and is not malfunction). You can reconnect to this broadband router and continue on other settings later.

You can click 'Continue' to continue on other settings without restart the broadband router, however, the changes you made will not take effect before you restart the broadband router.

### 3-4-1-4 AP Bridge-Point to Multi-Point

In this mode, you can use this broadband router as a wireless network bridge and let all computers connected to the LAN ports of all wireless access points to communicate with each other. **This mode supports up to four wireless access point peers.**

Please note that when you select this mode, this broadband router will act as wireless bridge only, and will not accept other wireless clients.

Also, you can connect to the wireless access point with the same functionality only. If you wish to connect to the wireless access points made by other manufacturer, please select 'AP Bridge-WDS' mode if the wireless access point you wish to connect supports WDS.

Here are descriptions of every setup items:

Item Name	Description
<i>Band</i>	<p><i>Please select the radio band from one of following options (must be the same with the wireless access point you wish to connect):</i></p> <p><i>2.4 GHz (B): 2.4GHz band, only allows 802.11b wireless network client to connect this router (maximum transfer rate 11Mbps).</i></p> <p><i>2.4 GHz (N): 2.4GHz band, only allows 802.11n wireless network client to connect this router (maximum transfer rate 150Mbps).</i></p> <p><i>2.4 GHz (B+G): 2.4GHz band, only allows 802.11b and 802.11g wireless network client to connect this router (maximum transfer rate 11Mbps for 802.11b clients, and maximum 54Mbps for 802.11g clients).</i></p> <p><i>2.4 GHz (G): 2.4GHz band, only allows 802.11g wireless network client to connect this</i></p>

	<p><i>router (maximum transfer rate 54Mbps).</i></p> <p><i>2.4 GHz (B+G+N): 2.4GHz Band, Allows 802.11b, 802.11g, and 802.11N wireless clients. It's recommends to select this band to maximize compatibility.</i></p>
<i>Channel Number</i>	<i>Select the channel number you wish to use; all access points must use the same channel.</i>
<i>MAC address 1 to 4</i>	<i>Input the MAC address of other wireless access points (the access points you wish to connect).</i>
<i>Set Security</i>	<i>Click 'Set Security' button to set security functions of this wireless connection to improve security. Please refer to chapter 3-2-1-7 for detailed instructions.</i>

When you finished with the settings in this page, you can click 'Apply' button to save changes you made in this page, or you can click 'Cancel' to discard changes. After you click 'Apply' button, you'll see the following messages:

**Save setting successfully!**

You may press CONTINUE button to continue configuring other settings or press APPLY button to restart the system for changes to take effect

Please click 'Apply' to save changes you made and restart the broadband router, this requires about 30 seconds and the broadband router will stop responding (this is normal and is not malfunction). You can reconnect to this broadband router and continue on other settings later.

You can click 'Continue' to continue on other settings without restart the broadband router, however, the changes you made will not take effect before you restart the broadband router.

### 3-4-1-5 AP Bridge-WDS

In this mode, this broadband router acts as both wireless communication bridge and wireless access point. This broadband router can establish communication with up to four WDS-compatible wireless access points, and let all computers connected to the LAN ports of every wireless access points communicate with each other. The broadband router is able to serve other wireless clients and acts as a wireless access point at the same time.

Mode :	AP Bridge-WDS
Band :	2.4 GHz (B+G+N)
ESSID :	EDIMAX
Channel Number :	7
Associated Clients :	Show Active Clients
MAC address 1 :	000000000000
MAC address 2 :	000000000000
MAC address 3 :	000000000000
MAC address 4 :	000000000000
Set Security :	Set Security

Here are descriptions of every setup items:

Item Name	Description
<i>Band</i>	<i>Please select the radio band from one of following options (must be the same with the wireless access point you wish to connect):</i>  <i>2.4 GHz (B): 2.4GHz band, only allows 802.11b wireless network client to connect this router (maximum transfer rate 11Mbps).</i>  <i>2.4 GHz (N): 2.4GHz band, only allows</i>

	<p><i>802.11n wireless network client to connect this router (maximum transfer rate 150Mbps).</i></p> <p><i>2.4 GHz (B+G): 2.4GHz band, only allows 802.11b and 802.11g wireless network client to connect this router (maximum transfer rate 11Mbps for 802.11b clients, and maximum 54Mbps for 802.11g clients).</i></p> <p><i>2.4 GHz (G): 2.4GHz band, only allows 802.11g wireless network client to connect this router (maximum transfer rate 54Mbps).</i></p> <p><i>2.4 GHz (B+G+N): 2.4GHz Band, Allows 802.11b, 802.11g, and 802.11N wireless clients. It's recommends to select this band to maximize compatibility.</i></p>
<i>ESSID</i>	<p><i>This is the name of broadband router. You can type any alphanumerical characters here, maximum 32 characters. ESSID is used to identify your own broadband router from others when there are other broadband routers in the same area. Default SSID is 'default', it's recommended to change default ESSID value to the one which is meaningful to you, like myhome, office_room1, etc.</i></p>
<i>Channel Number</i>	<p><i>Select the channel number you wish to use; all access points must use the same channel.</i></p>
<i>Associated Clients</i>	<p><i>Click 'Show Active Clients' button to show the list of all connected wireless clients. You can click 'Refresh' in new window to get latest list again, or click 'Close' to close the window.</i></p> <p><i>Please note that if you have pop-up blocker installed, you may have to disable it or tell your pop-up blocker to allow the popup window, or you will not be able to see the</i></p>

	<i>wireless client list window.</i>
<i>MAC address 1 to 4</i>	<i>Input the MAC address of other wireless access points (the access points you wish to connect).</i>
<i>Set Security</i>	<i>Click 'Set Security' button to set security functions of this wireless connection to improve security. Please refer to chapter 3-2-1-7 for detailed instructions.</i>

When you finished with the settings in this page, you can click 'Apply' button to save changes you made in this page, or you can click 'Cancel' to discard changes. After you click 'Apply' button, you'll see the following messages:

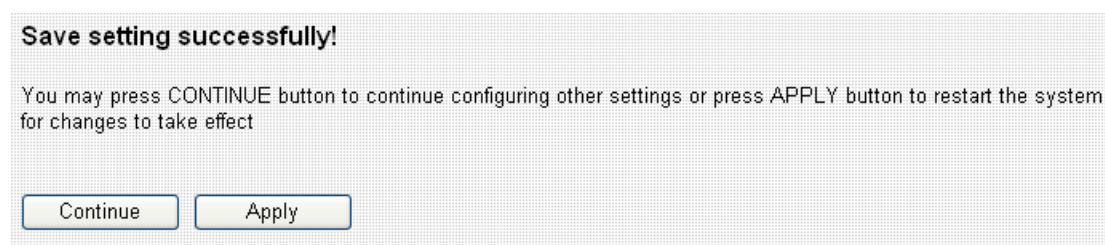

Please click 'Apply' to save changes you made and restart the broadband router, this requires about 30 seconds and the broadband router will stop responding (this is normal and is not malfunction). You can reconnect to this broadband router and continue on other settings later.

You can click 'Continue' to continue on other settings without restart the broadband router, however, the changes you made will not take effect before you restart the broadband router.

### 3-4-1-6 Universal Repeater

In this mode, this broadband router acts as a wireless repeater. It will repeat the signal of the wireless access point you specified, to extend its wireless coverage. The broadband router will still accept wireless clients when in this mode.



Mode :	Universal Repeater
Band :	2.4 GHz (B+G+N)
ESSID :	EDIMAX
Channel Number :	7
Associated Clients :	Show Active Clients
Root AP SSID :	EDIMAX
Site Survey :	Select Site Survey

Apply Cancel

Here are descriptions of every setup items:

Item Name	Description
<i>Band</i>	<p><i>Please select the radio band from one of following options (must be the same with the wireless access point you wish to connect):</i></p> <p><i>2.4 GHz (B): 2.4GHz band, only allows 802.11b wireless network client to connect this router (maximum transfer rate 11Mbps).</i></p> <p><i>2.4 GHz (N): 2.4GHz band, only allows 802.11n wireless network client to connect this router (maximum transfer rate 150Mbps).</i></p> <p><i>2.4 GHz (B+G): 2.4GHz band, only allows 802.11b and 802.11g wireless network client to connect this router (maximum transfer rate 11Mbps for 802.11b clients, and maximum 54Mbps for 802.11g clients).</i></p> <p><i>2.4 GHz (G): 2.4GHz band, only allows 802.11g wireless network client to connect this router (maximum transfer rate 54Mbps).</i></p> <p><i>2.4 GHz (B+G+N): 2.4GHz Band, Allows 802.11b, 802.11g, and 802.11N wireless clients. It's recommends to select this band to maximize compatibility.</i></p>
<i>ESSID</i>	<p><i>This is the name of broadband router. You can type any alphanumerical characters here, maximum 32 characters. ESSID is used to identify your own broadband router from others when there are other broadband routers in the same area. Default SSID is 'default', it's recommended to change default ESSID value to the one which is meaningful to you, like myhome, office_room1, etc.</i></p>

<i>Channel Number</i>	<i>Select the channel number you wish to use; all access points must use the same channel.</i>
<i>Associated Clients</i>	<p><i>Click 'Show Active Clients' button to show the list of all connected wireless clients. You can click 'Refresh' in new window to get latest list again, or click 'Close' to close the window.</i></p> <p><i>Please note that if you have pop-up blocker installed, you may have to disable it or tell your pop-up blocker to allow the popup window, or you will not be able to see the wireless client list window.</i></p>
<i>Root AP SSID</i>	<i>Please input the SSID of the wireless access point you wish to extend signal coverage.</i>
<i>Site Survey</i>	<p><i>Click 'Select Site Survey' and a popup window will appear. All reachable wireless access points will be shown in the window. Select the wireless access point you wish to connect from the list, and click 'Done'. If the wireless access point you wish to connect is not listed, you can click 'Refresh' to rescan.</i></p> <p><i>If you still can't find the wireless access point you wish to connect, please move the broadband router to the place nearer to the access point you wish to connect.</i></p>

When you finished with the settings in this page, you can click 'Apply' button to save changes you made in this page, or you can click 'Cancel' to discard changes. After you click 'Apply' button, you'll see the following messages:

**Save setting successfully!**

You may press CONTINUE button to continue configuring other settings or press APPLY button to restart the system for changes to take effect

Continue

Apply

Please click 'Apply' to save changes you made and restart the broadband router, this requires about 30 seconds and the broadband router will stop responding (this is normal and is not malfunction). You can reconnect to this broadband router and continue on other settings later.

You can click 'Continue' to continue on other settings without restart the broadband router, however, the changes you made will not take effect before you restart the broadband router.

### 3-4-1-7 Set Security

In certain AP working modes, you can enable encryption to improve security level.

When you click 'Set Security' button, the following window will appear:

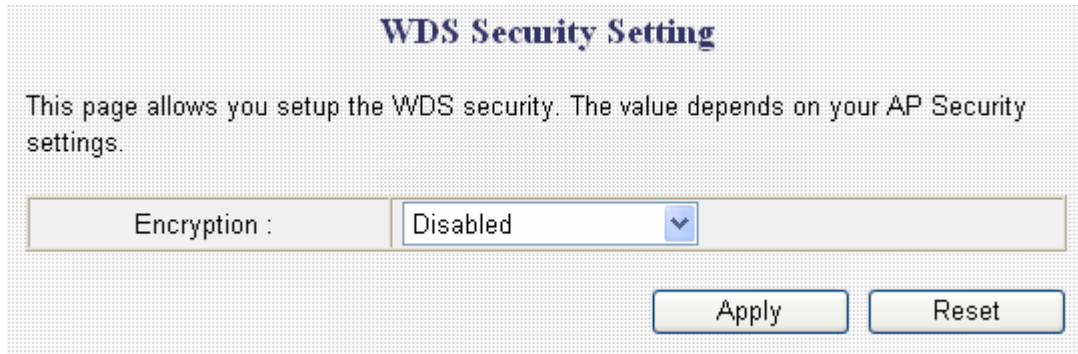

**WDS Security Setting**

This page allows you setup the WDS security. The value depends on your AP Security settings.

Encryption :

Please select an encryption method from 'Encryption' dropdown menu, and corresponding setting will appear:

#### *Disabled*

Encryption is disabled. It's **not recommended** to disable encryption because other people may use certain wireless scanner to copy the data transferred over air.

## WEP

Select WEP to enable WEP (Wired Equivalent Privacy) encryption:

Encryption :	WEP
Key Length :	64-bit
Key Format :	Hex (10 characters)
Default Tx Key :	Key 1
Encryption Key 1 :	*****
Encryption Key 2 :	*****
Encryption Key 3 :	*****
Encryption Key 4 :	*****

Here are descriptions of every setup items:

Item Name	Description
<i>Key Length</i>	<i>There are two types of WEP key length: 64-bit and 128-bit. Using '128-bit' is safer than '64-bit', but will reduce some data transfer performance.</i>
<i>Key Format</i>	<i>There are two types of key format: ASCII and Hex. When you select a key format, the number of characters of key will be displayed. For example, if you select '64-bit' as key length, and 'Hex' as key format, you'll see the message at the right of 'Key Format' is 'Hex (10 characters)', which means the length of WEP key is 10 characters.</i>
<i>Default Tx Key</i>	<i>You can set up to four sets of WEP key, and you can decide which key is being used by default here. <b>If you don't know which one you should use, select 'Key 1'.</b></i>
<i>Encryption Key 1 to 4</i>	<i>Input WEP key characters here, the number of characters must be the same as the number</i>

*displayed at 'Key Format' field. You can use any alphanumerical characters (0-9, a-z, and A-Z) if you select 'ASCII' key format, and if you select 'Hex' as key format, you can use characters 0-9, a-f, and A-F. You must enter at least one encryption key here, and if you entered multiple WEP keys, they should not be same with each other.*

Please click 'Apply' to save changes, or click 'Reset' to clear the texts in all fields. If you click 'Apply', the following messages will appear:

**Save setting successfully!**

You may press CONTINUE button to continue configuring other settings or press APPLY button to restart the system for changes to take effect

You can click 'Continue' to back to previous page and continue setting, or click 'Apply' to restart the broadband router so the changes will take effect.

*WPA pre-shared key*

WPA (Wi-Fi Protected Access) is also an encryption method and is safer than WEP. It's recommended to use WPA instead of WEP when you need to use encryption to protect your data security.

Encryption :	<input type="text" value="WPA pre-shared key"/>
WPA Unicast Cipher Suite :	<input checked="" type="radio"/> WPA(TKIP) <input type="radio"/> WPA2(AES)
Pre-shared Key Format :	<input type="text" value="Passphrase"/>
Pre-shared Key :	<input type="text"/>

Here are descriptions of every setup items:

Item Name	Description
<i>WPA Unicast Cipher Suite</i>	<i>Please select a type of WPA cipher suite. Available options are: WPA (TKIP), WPA2 (AES), and WPA2 Mixed. You can select one of them, but you have to make sure your wireless client support the cipher you selected.</i>
<i>Pre-shared Key Format</i>	<i>Select the type of pre-shared key, you can select Passphrase (8 or more alphanumerical characters, up to 63), or Hex (64 characters of 0-9, and a-f).</i>
<i>Pre-shared Key</i>	<i>Please input the WPA passphrase here. <b>It's not recommended to use a word that can be found in a dictionary due to security reason.</b></i>

Please click 'Apply' to save changes, or click 'Reset' to clear the texts in all fields. If you click 'Apply', the following messages will appear:

**Save setting successfully!**

You may press CONTINUE button to continue configuring other settings or press APPLY button to restart the system for changes to take effect

You can click 'Continue' to back to previous page and continue setting, or click 'Apply' to restart the broadband router so the changes will take effect.

### 3-4-2 Security Settings

This wireless router supports two types of encryption: WEP (Wired Equivalent Privacy) and WPA (Wi-Fi Protected Access):

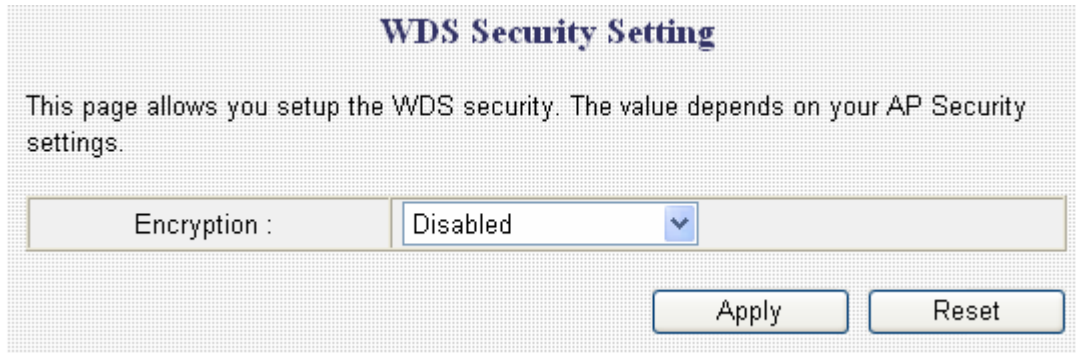

**WDS Security Setting**

This page allows you setup the WDS security. The value depends on your AP Security settings.

Encryption :

Please select an encryption method from ‘Encryption’ dropdown menu, and corresponding setting will appear:

#### *Disabled*

Encryption is disabled. It’s **not recommended** to disable encryption because other people may use certain wireless scanner to copy the data transferred over air.

## WEP

Select WEP to enable WEP (Wired Equivalent Privacy) encryption:

Encryption :	WEP
Key Length :	64-bit
Key Format :	Hex (10 characters)
Default Tx Key :	Key 1
Encryption Key 1 :	*****
Encryption Key 2 :	*****
Encryption Key 3 :	*****
Encryption Key 4 :	*****
<input type="button" value="Apply"/> <input type="button" value="Reset"/>	

Here are descriptions of every setup items:

Item Name	Description
<i>Key Length</i>	<i>There are two types of WEP key length: 64-bit and 128-bit. Using '128-bit' is safer than '64-bit', but will reduce some data transfer performance.</i>
<i>Key Format</i>	<i>There are two types of key format: ASCII and Hex. When you select a key format, the number of characters of key will be displayed. For example, if you select '64-bit' as key length, and 'Hex' as key format, you'll see the message at the right of 'Key Format' is 'Hex (10 characters)', which means the length of WEP key is 10 characters.</i>
<i>Default Tx Key</i>	<i>You can set up to four sets of WEP key, and you can decide which key is being used by default here. <b>If you don't know which one you should use, select 'Key 1'.</b></i>
<i>Encryption Key 1 to 4</i>	<i>Input WEP key characters here, the number of characters must be the same as the number</i>

*displayed at 'Key Format' field. You can use any alphanumerical characters (0-9, a-z, and A-Z) if you select 'ASCII' key format, and if you select 'Hex' as key format, you can use characters 0-9, a-f, and A-F. You must enter at least one encryption key here, and if you entered multiple WEP keys, they should not be same with each other.*

Please click 'Apply' to save changes, or click 'Reset' to clear the texts in all fields. If you click 'Apply', the following messages will appear:

**Save setting successfully!**

You may press CONTINUE button to continue configuring other settings or press APPLY button to restart the system for changes to take effect

You can click 'Continue' to back to previous page and continue setting, or click 'Apply' to restart the broadband router so the changes will take effect.

*WPA pre-shared key*

WPA (Wi-Fi Protected Access) is also an encryption method and is safer than WEP. It's recommended to use WPA instead of WEP when you need to use encryption to protect your data security.

Encryption :	<input type="text" value="WPA pre-shared key"/>
WPA Unicast Cipher Suite :	<input checked="" type="radio"/> WPA(TKIP) <input type="radio"/> WPA2(AES)
Pre-shared Key Format :	<input type="text" value="Passphrase"/>
Pre-shared Key :	<input type="text"/>

Here are descriptions of every setup items:

Item Name	Description
<i>WPA Unicast Cipher Suite</i>	<i>Please select a type of WPA cipher suite. Available options are: WPA (TKIP), WPA2 (AES), and WPA2 Mixed. You can select one of them, but you have to make sure your wireless client support the cipher you selected.</i>
<i>Pre-shared Key Format</i>	<i>Select the type of pre-shared key, you can select Passphrase (8 or more alphanumerical characters, up to 63), or Hex (64 characters of 0-9, and a-f).</i>
<i>Pre-shared Key</i>	<i>Please input the WPA passphrase here. <b>It's not recommended to use a word that can be found in a dictionary due to security reason.</b></i>

Please click 'Apply' to save changes, or click 'Reset' to clear the texts in all fields. If you click 'Apply', the following messages will appear:

**Save setting successfully!**

You may press CONTINUE button to continue configuring other settings or press APPLY button to restart the system for changes to take effect

You can click 'Continue' to back to previous page and continue setting, or click 'Apply' to restart the broadband router so the changes will take effect.

## *WPA RADIUS*

If you have RADIUS authentication server on your local network, you can authenticate the wireless clients by RADIUS server's user database. Only authenticated clients can establish wireless connection with this broadband router.

<b>Encryption :</b>	WPA RADIUS
<b>WPA Unicast Cipher Suite :</b>	<input checked="" type="radio"/> WPA(TKIP) <input type="radio"/> WPA2(AES) <input type="radio"/> WPA2 Mixed
<b>RADIUS Server IP address :</b>	<input type="text"/>
<b>RADIUS Server Port :</b>	1812
<b>RADIUS Server Password :</b>	<input type="text"/>
<input type="button" value="Apply"/> <input type="button" value="Cancel"/>	

Here are descriptions of every setup items:

Item Name	Description
<i>WPA Unicast Cipher Suite</i>	<i>Please select a type of WPA cipher suite. Available options are: WPA (TKIP), WPA2 (AES), and WPA2 Mixed. You can select one of them, but you have to make sure your wireless client support the cipher you selected.</i>
<i>RADIUS Server IP address</i>	<i>Input the IP address of RADIUS authentication server here.</i>
<i>RADIUS Server Port</i>	<i>Input the port number of RADIUS authentication server here. Most of RADIUS server will use port number 1812 and you can keep using default value.</i>
<i>RADIUS Server Password</i>	<i>Input the password of RADIUS authentication server here.</i>

Please click 'Apply' to save changes, or click 'Reset' to clear the texts in all fields. If you click 'Apply', the following messages will appear:

**Save setting successfully!**

You may press CONTINUE button to continue configuring other settings or press APPLY button to restart the system for changes to take effect

You can click 'Continue' to back to previous page and continue setting, or click 'Apply' to restart the broadband router so the changes will take effect.

### 3-4-3 MAC Address Filtering

This function will help you to prevent unauthorized users from connecting to your wireless router; only those wireless devices who have the MAC address you assigned here can gain access to your wireless router. You can use this function with other security measures described in previous section, to create a safer wireless environment. Up to 20 MAC addresses can be assigned.

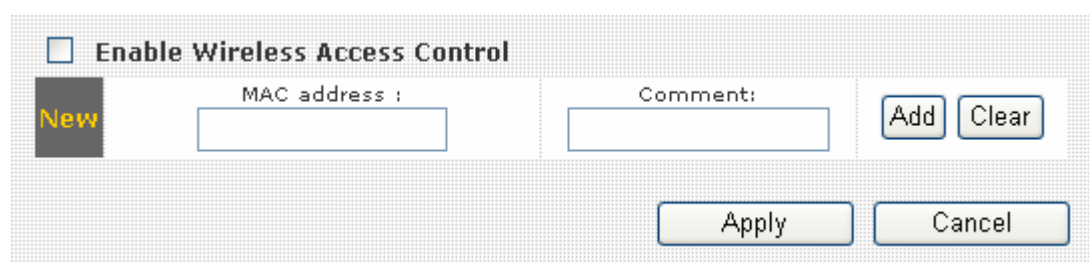

The screenshot shows a web-based configuration interface for MAC address filtering. At the top, there is a checkbox labeled "Enable Wireless Access Control". Below this, there is a "New" button on the left. To its right are two input fields: "MAC address :" and "Comment:". To the right of the "Comment:" field are two buttons: "Add" and "Clear". At the bottom of the interface, there are two buttons: "Apply" and "Cancel".

To enable MAC address filtering, please check 'Enable Wireless Access Control' box in this page, the descriptions of other setting items are listed as follow:

Item Name	Description
<i>MAC address</i>	<i>Input the MAC address you wish to add to the MAC address to the table.</i>
<i>Comment</i>	<i>You can input any text here as the comment of this MAC address, like 'ROOM 2A Computer' or anything. You can input up to 16 alphanumerical characters here. This is optional and you can leave it blank, however, it's recommended to use this field to write a comment for every MAC addresses as a memory aid.</i>
<i>Add</i>	<i>Click 'Add' button to add the MAC address and associated comment to the MAC address filtering table.</i>
<i>Clear</i>	<i>Click 'Clear' to remove the value you inputted in MAC address and comment field.</i>

All MAC address entries will be listed in this page:

NO.	MAC address	Comment	Select
1	11:22:33:44:55:66	John's Computer	<input type="checkbox"/>
2	aa:bb:cc:dd:ee:ff	Mary's Computer	<input type="checkbox"/>

To delete one or more entries listed here, please check the box of the mapping entry (under 'Select'), and click 'Delete Selected' button.

If you wish to delete all mapping entries, click 'Delete All' button. To deselect all checked boxes, click 'Reset' button.

When you finished with the settings in this page, you can click 'Apply' button to save changes you made in this page, or you can click 'Cancel' to discard changes. After you click 'Apply' button, you'll see the following messages:

**Save setting successfully!**

Please press APPLY button to restart the system for changes to take effect.

Please click 'Apply' to save changes you made and restart the broadband router, this requires about 30 seconds and the broadband router will stop responding (this is normal and is not malfunction). You can reconnect to this broadband router and continue on other settings later.

### 3-4-4 WPS

WPS (Wi-Fi Protected Setup) provides a convenient way to establish the connection between this broadband router and wireless clients. Any WPS-compatible wireless clients can establish secure connection with this broadband router with simple push-button type configuration or PinCode type configuration.

**Enable WPS**

- Wi-Fi Protected Setup Information
  - WPS Status:** Configured
  - Self PinCode:** 26460963
  - SSID:** EDIMAX
  - Authentication Mode:** WEP
  - Passphrase Key:**
- Device Configure
  - Config Mode:** Registrar ▾
  - Configure via Push Button:** Start PBC
  - Configure via Client PinCode:**  Start PIN

Here are descriptions of every setup items:

Item Name	Description
<i>Enable WPS</i>	<i>Check this box to enable WPS function, uncheck it to disable WPS.</i>
<i>WPS Status</i>	<i>If the wireless security (encryption) function of this wireless router is properly set, you'll see 'Configured' message here. If wireless security function has not been set, you'll see 'unConfigured'.</i>
<i>Self PIN code</i>	<i>This is the WPS PIN code of this wireless router. This code is useful when you need to build wireless connection by WPS with other WPS-enabled wireless devices.</i>
<i>SSID</i>	<i>The SSID of this wireless router will be</i>

	<i>displayed here.</i>
<i>Authentication Mode</i>	<i>The wireless security authentication mode of this wireless router will be displayed here.</i>
<i>Passphrase Key</i>	<i>The WPA passphrase will be displayed as asterisk here.</i>
<i>Config Mode</i>	<p><i>Select the WPS configuration role of this broadband router.</i></p> <p><i>Registrar: This broadband router will act as WPS registrar and wait for wireless clients to send WPS configuration request.</i></p> <p><i>Enrollee: This broadband router will act as WPS enrollee and send WPS configuration request to other WPS registrar.</i></p>
<i>Configure via Push Button</i>	<p><i>Click 'Start PBC' to start Push-Button type WPS configuration (PBC). Please push the WPS push-button on other WPS-compatible network devices to begin WPS configuration.</i></p> <p><i>You can also push the 'WPS / Reset' button located at the back of this broadband router to start PBC without using web configuration interface.</i></p>
<i>Configure via Client PinCode</i>	<i>Please input the PinCode displayed at the configuration software of WPS-enabled wireless client, and click 'Start PIN' to establish connection with the wireless client.</i>

### 3-5 Advance Settings\*

This router provides various network functionalities like QoS and NAT, and you can configure these functions in ‘Advanced Settings’ menu.

<input type="radio"/>	<b>QoS</b>	Quality of Service (QoS) refers to the capability of a network to provide better service to selected network traffic. The primary goal of QoS is to provide priority including dedicated bandwidth, controlled jitter and latency (required by some real-time and interactive traffic), and improved loss characteristics. Also important is making sure that providing priority for one or more flows does not make other flows fail.
<input type="radio"/>	<b>NAT</b>	Network Address Translation (NAT) allows multiple users at your local site to access the Internet through a single Public IP Address or multiple Public IP Addresses. NAT provides Firewall protection from hacker attacks and has the flexibility to allow you to map Private IP Addresses to Public IP Addresses for key services such as the Web or FTP.
<input type="radio"/>	<b>Firewall</b>	The Broadband router provides extensive firewall protection by restricting connection parameters, thus limiting the risk of hacker attack, and defending against a wide array of common attacks. However, for applications that require unrestricted access to the Internet, you can configure a specific client/server as a Demilitarized Zone (DMZ).
<input type="radio"/>	<b>DDNS</b>	DDNS allows users to map the static domain name to a dynamic IP address. You must get a account, password and your static domain name from the DDNS service providers. Our products have DDNS support for <a href="http://www.dyndns.org">www.dyndns.org</a> and <a href="http://www.tzo.com">www.tzo.com</a> now.
<input type="radio"/>	<b>Port Forwarding</b>	Entries in this table allow you to automatically redirect common network services to a specific machine behind the NAT firewall. These settings are only necessary if you wish to host some sort of server like a web server or mail server on the private local network behind your Gateway's NAT firewall.
<input type="radio"/>	<b>DMZ(Demilitarized Zone)</b>	If you have a local client PC that cannot run an Internet application properly from behind the NAT firewall, then you can open the client up to unrestricted two-way Internet access by defining a Virtual DMZ Host.

Please select the function you wish to set, then click ‘Apply’ button. If you wish to go back to previous page, click ‘Previous’ button.

### 3-5-1 QoS

Quality of service provides an efficient way for computers on the network to share the internet bandwidth with a promised quality of internet service. Without QoS, all computers and devices on the network will compete with each other to get internet bandwidth, and some applications which require guaranteed bandwidth (like video streaming and network telephone) will be affected, therefore an unpleasing result will occur, like the interruption of video / audio transfer.

With this function, you can limit the maximum bandwidth or give a guaranteed bandwidth for a specific computer, to avoid said unpleasing result from happening.

#### 3-5-1-1 Basic QoS Settings

Enable QoS

**Total Download Bandwidth:**  kbits

**Total Upload Bandwidth:**  kbits

Current QoS Table

Priority	Rule Name	Upload Bandwidth	Download Bandwidth	Select
----------	-----------	------------------	--------------------	--------

Here are descriptions of every setup items:

Item Name	Description
<i>Enable QoS</i>	<i>Check this box to enable QoS function, uncheck it to disable QoS.</i>
<i>Total Download Bandwidth</i>	<i>You can set the limit of total download bandwidth in kbits. To disable download bandwidth limitation, input '0' here.</i>
<i>Total Upload Bandwidth</i>	<i>You can set the limit of total upload bandwidth in kbits. To disable upload bandwidth limitation, input '0' here.</i>
<i>Add</i>	<i>Click 'add' button to add a new QoS rule (detailed instructions will be given below).</i>

<i>Edit</i>	<i>If you want to modify the content of a specific rule, please check the 'select' box of the rule you want to edit, then click 'Edit' button. <b>Only one rule should be selected a time!</b> If you didn't select a rule before clicking 'Edit' button, you'll be prompted to add a new rule.</i>
<i>Delete Selected</i>	<i>You can delete selected rules by clicking this button. You can select one or more rules to delete by check the 'select' the box of the rule(s) you want to delete a time. <b>If the QoS table is empty, this button will be grayed out and can not be clicked.</b></i>
<i>Delete All</i>	<i>By clicking this button, you can delete all rules currently listed in the QoS table. <b>If the QoS table is empty, this button will be grayed out and can not be clicked.</b></i>
<i>Move Up</i>	<i>Move selected item up.</i>
<i>Move Down</i>	<i>Move selected item down.</i>
<i>Reset</i>	<i>If you want to erase all values you just entered. Click 'Reset'</i>

When you finished with the settings in this page, you can click 'Apply' button to save changes you made in this page, or you can click 'Cancel' to discard changes. After you click 'Apply' button, you'll see the following messages:

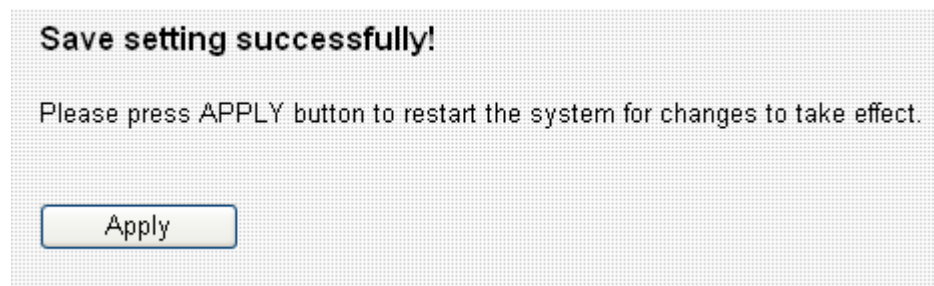

Please click 'Apply' to save changes you made and restart the broadband router, this requires about 30 seconds and the broadband router will stop responding (this is normal and is not malfunction). You can reconnect to this broadband router and continue on other settings later.

### 3-5-1-2 Add a new QoS entry

After you click 'Add' button in QoS menu, a new setting page will appear:

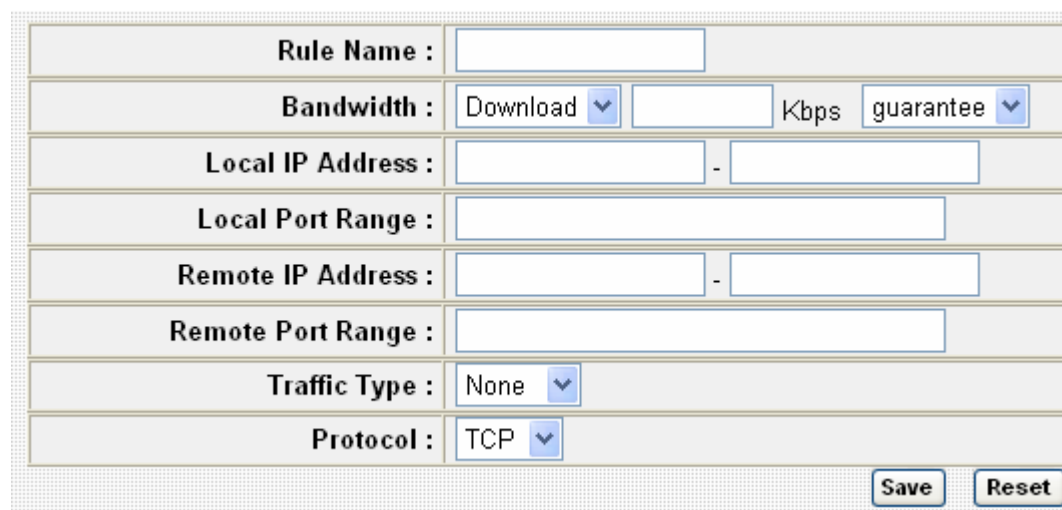

The screenshot shows a configuration form for a QoS rule. It consists of several rows, each with a label and a corresponding input field or dropdown menu. The fields are: Rule Name (text input), Bandwidth (direction dropdown, value input, unit dropdown), Local IP Address (two text inputs separated by a hyphen), Local Port Range (text input), Remote IP Address (two text inputs separated by a hyphen), Remote Port Range (text input), Traffic Type (dropdown menu), and Protocol (dropdown menu). At the bottom right, there are 'Save' and 'Reset' buttons.

Here are descriptions of every setup items:

Item Name	Description
<i>Rule Name</i>	<i>Please give a name to this QoS rule (up to 15 alphanumerical characters).</i>
<i>Bandwidth</i>	<i>Set the bandwidth limitation of this QoS rule. You have to select the data direction of this rule (Upload or Download), and the speed of bandwidth limitation in Kbps, then select the type of QoS: 'guarantee' (guaranteed usable bandwidth for this rule) or 'max' (set the maximum bandwidth for the application allowed by this rule).</i>
<i>Local IP Address</i>	<i>Specify the local (source) IP address that will be affected by this rule. Please input the starting IP address in the left field, and input the end IP address in the right field to define a range of IP addresses, or just input the IP address in the left field to define a single IP address.</i>
<i>Local Port Range</i>	<i>Please input the range of local (source) port</i>

	<i>number that will be affected by this rule. If you want to apply this rule on port 80 to 90, please input '80-90'; if you want to apply this rule on a single port, just input the port number, like '80'</i>
<i>Remote IP Address</i>	<i>Specify the remote (destination) IP address that will be affected by this rule. Please input the starting IP address in the left field, and input the end IP address in the right field to define a range of IP addresses, or just input the IP address in the left field to define a single IP address.</i>
<i>Remote Port Range</i>	<i>Please input the range of remote (destination) port number that will be affected by this rule. If you want to apply this rule on port 80 to 90, please input '80-90'; if you want to apply this rule on a single port, just input the port number, like '80'. If the remote (destination) IP address and /or port number is universal, just leave it blank.</i>
<i>Traffic Type</i>	<i>Please select the traffic type of this rule, available options are None, SMTP, HTTP, POP3, and FTP. You can select a specific traffic type for this rule, if you want to make this rule as a IP address based rule (apply the limitation on all traffics from / to the specified IP address / port number), select 'None'.</i>
<i>Protocol</i>	<i>Please select the protocol type of this rule, available options are TCP and UDP. If you don't know what protocol your application uses, please try 'TCP' first, and switch to 'UDP' if this rule doesn't seems to work.</i>

Please click 'save' button to save settings, and the rule you just set will appear in current QoS table; if you did anything wrong, you'll get an error message when you click 'Save' button, please correct your input by the instructions given by the error message. If you want to erase all values you just entered, click 'Reset'.

### 3-5-2 NAT

Network address translations solve the problem if sharing a single IP address to multiple computers. Without NAT, all computers must be assigned with a valid Internet IP address to get connected to Internet, but Internet service providers only provide very few IP addresses to every user. Therefore it's necessary to use NAT technology to share a single Internet IP address to multiple computers on local network, so everyone can get connected to Internet.

This broadband router supports four types of NAT functions, and the instructions of these functions will be given below.

#### 3-5-2-1 Virtual Server

This function allows you to redirect a port on Internet IP address (on WAN port) to a specified port of an IP address on local network, so you can setup an Internet service on the computer on local network, without exposing it on Internet directly. You can also build many sets of port redirection, to provide many different Internet services on different local computers via a single Internet IP address.

Enable Virtual Server

Private IP	Computer name	Private Port	Type	Public Port	Comment
<input type="text"/>	<< -----Select----- >>	<input type="text"/>	Both	<input type="text"/>	<input type="text"/>

**Current Virtual Server Table:**

NO.	Computer name	Private IP	Private Port	Type	Public Port	Comment	Select
-----	---------------	------------	--------------	------	-------------	---------	--------

Here are descriptions of every setup items:

Item Name	Description
<i>Enable Virtual Server</i>	<i>Check this box to enable virtual server, and uncheck this box to disable virtual server.</i>
<i>Private IP</i>	<i>Input the IP address of the computer which provides Internet service.</i>
<i>Computer name</i>	<i>All computer names found by this broadband router on local network will be listed here. You can select the computer name and click '&lt;&lt;' button to add selected computer's IP address to 'Private IP' field.  Please note that this list may not be able to list all computers on your local network.</i>
<i>Private Port</i>	<i>Input the port number of the IP address which provides Internet service.</i>
<i>Type</i>	<i>Select the type of connection, TCP or UDP. If you're not sure, please select 'Both'</i>
<i>Public Port</i>	<i>Please select the port number of Internet IP address which will be redirected to the port number of local IP address defined above.</i>
<i>Comment</i>	<i>Please input any text to describe this mapping, up to 16 alphanumerical characters.</i>
<i>Add</i>	<i>Add the mapping to virtual server table.</i>
<i>Reset</i>	<i>Remove all inputted values.</i>

All existing virtual server mappings will be displayed in this page. To delete one or more mappings, check the box of the mapping, then click 'Delete Selected' button to remove the mapping. To delete all existing mappings, click 'Delete All' button. If you want to uncheck all boxes, click 'Reset'.

When you finished with the settings in this page, you can click 'Apply' button to save changes you made in this page, or you can click 'Cancel' to discard changes. After you click 'Apply' button, you'll see the following messages:

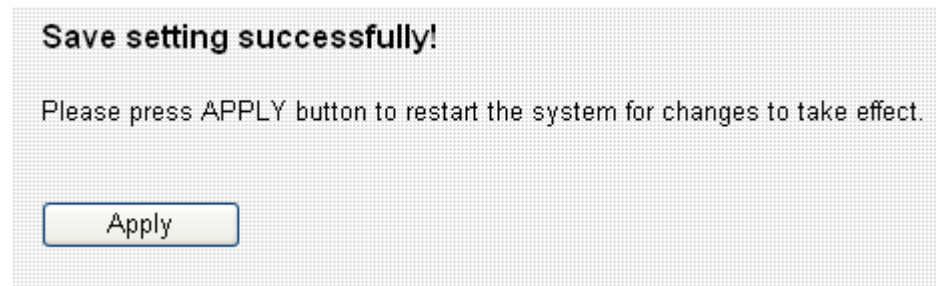

Please click 'Apply' to save changes you made and restart the broadband router, this requires about 30 seconds and the broadband router will stop responding (this is normal and is not malfunction). You can reconnect to this broadband router and continue on other settings later.

### 3-5-2-2 Special Applications

Some applications require more than one connection a time; these applications won't work with simple NAT rules. In order to make these applications work, you can use this function to let these applications work.

Here are descriptions of every setup items:

Item Name	Description
<i>Enable</i>	<i>Check this box to enable support for special applications, and uncheck this box to disable this support.</i>
<i>IP Address</i>	<i>Input the IP address of the computer which is going to use the special application.</i>
<i>Computer name</i>	<i>All computer names found by this broadband router on local network will be listed here. You can select the computer name and click '&lt;&lt;' button to add selected computer's IP address to 'IP Address' field.</i>  <i>Please note that this list may not be able to list all computers on your local network.</i>
<i>TCP Port to Open</i>	<i>Input the TCP port number required by the special application, the port number can be a</i>

	<i>single value, or a range (like 20-50). If you need to input more than one port number and they're not contiguous, list all port numbers here and separate them by comma ( , ). If the application does not use TCP port, leave it blank.</i>
<i>UDP Port to Open)</i>	<i>Input the UDP port number required by the special application, the port number can be a single value, or a range (like 20-50). If you need to input more than one port number and they're not contiguous, list all port numbers here and separate them by comma ( , ). If the application does not use UDP port, leave it blank.</i>
<i>Comment</i>	<i>You can input any text here to help you remember the purpose of this item. This is optional.</i>
<i>Select Game</i>	<i>This router comes with a numerous port mapping settings of network games. If the game you wish to set is listed here, you can select it from dropdown menu.</i>  <i>After a game is selected, click 'Add' (the one next to 'Select Game' dropdown list) to add the connection parameters to all respective fields.</i>
<i>Add</i>	<i>Click this button to add a new port mapping rule to special applications table.</i>
<i>Reset</i>	<i>Click this button to remove all values in every field.</i>

All existing special application mappings will be displayed in this page. To delete one or more mappings, check the box of the mapping, then click 'Delete Selected' button to remove the mapping. To delete all existing mappings, click 'Delete All' button. If you want to uncheck all boxes, click 'Reset'.

When you finished with the settings in this page, you can click 'Apply' button to save changes you made in this page, or you can click 'Cancel' to discard changes. After you click 'Apply' button, you'll see the following messages:

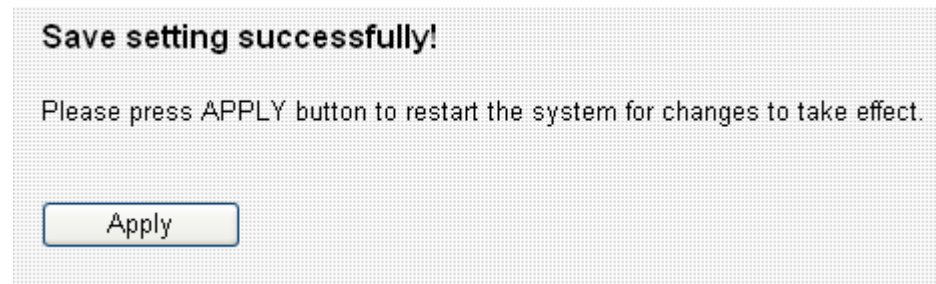

Please click 'Apply' to save changes you made and restart the broadband router, this requires about 30 seconds and the broadband router will stop responding (this is normal and is not malfunction). You can reconnect to this broadband router and continue on other settings later.

### 3-5-2-3 Firewall

This broadband router supports several firewall functions which will help you to protect your network and computer. In this chapter, instructions for using these functions will be given, so you can utilize these functions to protect your network from hackers and malicious intruders.

#### 3-5-2-3-1 Access Control

By using access control, you can restrict your computers from accessing improper website, or using disallowed applications. You can even only allow computers with certain MAC address to access the network, or deny the computers in the list from accessing your network.

Enable MAC Filtering    Deny    Allow

Client PC MAC address	Computer name	Comment
<input type="text"/>	<< -----Select----- >>	<input type="text"/>

**MAC Filtering Table**

NO.	Computer name	Client PC MAC address	Comment	Select
1	OFFLINE	aa:bb:cc:dd:ee:ff	Office PC	<input type="checkbox"/>
2	OFFLINE	11:22:33:44:55:66	lab 1	<input type="checkbox"/>

Here are descriptions of every setup items:

Item Name	Description
<i>Enable MAC Filtering</i>	<i>Check this box to enable MAC address based filtering, and please select 'Deny' or 'Allow' to decide the behavior of MAC filtering table. If you select deny, all MAC addresses listed in filtering table will be denied from connecting to the network; if you select allow, only MAC addresses listed in filtering table will be able to connect to the network, and rejecting all other</i>

	<i>network devices.</i>
<i>Client PC MAC address</i>	<i>Please input the MAC address of computer or network device here, dash ( - ) or colon ( : ) are not required. (i.e. If the MAC address label of your wireless device indicates 'aa-bb-cc-dd-ee-ff' or 'aa:bb:cc:dd:ee:ff', just input 'aabbccddeeff')</i>
<i>Computer Name</i>	<i>All computer names found by this broadband router on local network will be listed here. You can select the computer name and click '&lt;&lt;' button to add selected computer's IP address to 'Private IP' field.</i>  <i>Please note that this list may not be able to list all computers on your local network.</i>
<i>Comment</i>	<i>You can input any text here as the comment of this MAC address, like 'ROOM 2A Computer' or anything. You can input up to 16 alphanumerical characters here. This is optional and you can leave it blank, however, it's recommended to use this field to write a comment for every MAC addresses as a memory aid.</i>
<i>Add</i>	<i>Click 'Add' button to add the MAC address and associated comment to the MAC address filtering table.</i>
<i>Reset</i>	<i>Remove all inputted values.</i>

All MAC address entries will be listed in this page:

MAC Filtering Table				
NO.	Computer name	Client PC MAC address	Comment	Select
1	OFFLINE	aa:bb:cc:dd:ee:ff	Office PC	<input type="checkbox"/>
2	OFFLINE	11:22:33:44:55:66	lab 1	<input type="checkbox"/>

To delete one or more entries listed here, please check the box of the mapping entry (under 'Select'), and click 'Delete Selected' button.

If you wish to delete all mapping entries, click 'Delete All' button. To deselect all checked boxes, click 'Reset' button.

If you wish to use IP address-based filtering, please use 'IP Filtering Table' in this page:

<input type="checkbox"/> Enable IP Filtering Table (up to 20 computers) <input checked="" type="radio"/> Deny <input type="radio"/> Allow						
NO.	Client PC Description	Client PC IP address	Client Service	Protocol	Port Range	Select
1	POS	192.168.98.150	E-mail Sending			<input type="checkbox"/>

Please check 'Enable IP Filtering Table' box first, and select 'Deny' or 'Allow' to decide the behavior of IP filtering table (Deny the access of IP addresses in the list, or allow the access of IP addressees in the list). You have to click 'Add PC' button to add a new IP address to the list:

### Access Control Add PC

This page allows users to define service limitation of client PC, including IP address and service type.

Client PC Description :	<input type="text"/>
Client PC IP address :	<input type="text"/> - <input type="text"/>

Here are descriptions of every setup items:

Item Name	Description
<i>Client PC Description</i>	<i>Please input any text to describe this IP address, up to 16 alphanumerical characters.</i>
<i>Client PC IP address</i>	<i>Please input the starting IP address in the left field, and input the end IP address in the right field to define a range of IP addresses, or just input the IP address in the left field to define a single IP address.</i>

You also have to select the type of Internet services that will be applied to this access control rule from the list:

Client PC Service :		
Service Name	Detail Description	Select
WWW	HTTP, TCP Port 80, 3128, 8000, 8080, 8081	<input type="checkbox"/>
E-mail Sending	SMTP, TCP Port 25	<input type="checkbox"/>
News Forums	NNTP, TCP Port 119	<input type="checkbox"/>
E-mail Receiving	POP3, TCP Port 110	<input type="checkbox"/>
Secure HTTP	HTTPS, TCP Port 443	<input type="checkbox"/>
File Transfer	FTP, TCP Port 21	<input type="checkbox"/>
MSN Messenger	TCP Port 1863	<input type="checkbox"/>
Telnet Service	TCP Port 23	<input type="checkbox"/>
AIM	AOL Instant Messenger, TCP Port 5190	<input type="checkbox"/>
NetMeeting	H.323, TCP Port 389,522,1503,1720,1731	<input type="checkbox"/>
DNS	UDP Port 53	<input type="checkbox"/>
SNMP	UDP Port 161, 162	<input type="checkbox"/>
VPN-PPTP	TCP Port 1723	<input type="checkbox"/>
VPN-L2TP	UDP Port 1701	<input type="checkbox"/>
TCP	All TCP Port	<input type="checkbox"/>
UDP	All UDP Port	<input type="checkbox"/>

You can select multiple services here. If you wish to deny or allow all services of certain IP address(es), please select both 'TCP' and 'UDP'.

If the service you wish to deny or allow is not listed, you can use 'User Define Service' table to add a new service of your own:

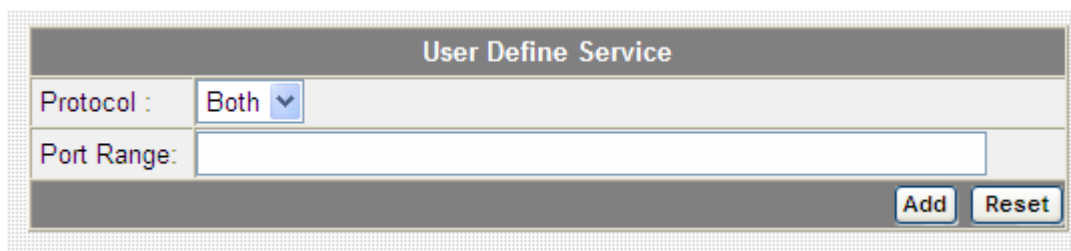

Here are descriptions of every setup items:

Item Name	Description
<i>Protocol</i>	<i>Please select the protocol type of this service: TCP or UDP, or 'Both'.</i>
<i>Port Range</i>	<i>Please input the port range if this service. For a single port number, just input the number of service port (like '110').  If this service consists multiple continuous ports, you can input '110-120' for port number 110 to 120, or '110,115,120' for port number 110, 115, and 120.</i>

Click 'Add' to add this IP address restriction rule to the list (and back to previous page), or click 'Reset' to clear all texts in every field.

When you finished with the settings in this page, you can click 'Apply' button to save changes you made in this page, or you can click 'Cancel' to discard changes. After you click 'Apply' button, you'll see the following messages:

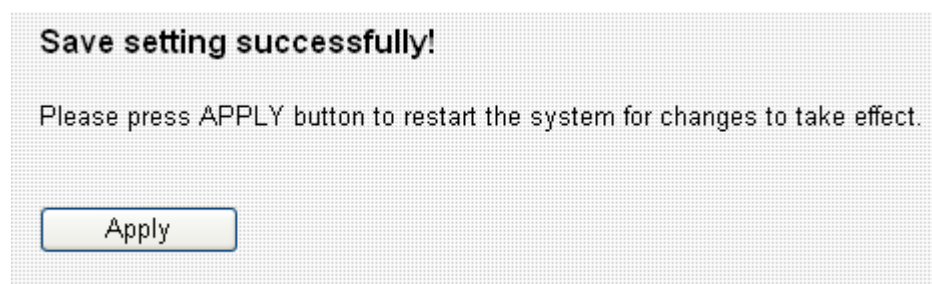

Please click 'Apply' to save changes you made and restart the broadband router, this requires about 30 seconds and the broadband router will stop responding (this is normal and is not malfunction). You can reconnect to this broadband router and continue on other settings later.

### 3-5-2-3-2 URL Blocking

If you want to prevent computers in local network from accessing certain website (like pornography, violence, or anything you want to block), you can use this function to stop computers in local network from accessing the site you defined here.

This function is useful for parents and company managers.

Please follow the following instructions to set URL blocking parameters:

Please click 'Firewall' menu on the left of web management interface, then click 'URL Blocking', and the following message will be displayed on your web browser:

**URL Blocking**

You can block access to certain Web sites from a particular PC by entering either a full URL address or just a keyword of the Web site.

Enable URL Blocking

URL/Keyword

**Current URL Blocking Table:**

NO.	URL/Keyword	Select
1	www.playboy.com	<input type="checkbox"/>

Here are descriptions of every setup items:

Item Name	Description
<i>Enable URL Blocking</i>	<i>Check this box to enforce URL Blocking, uncheck it to disable URL Blocking.</i>
<i>URL/Keyword</i>	<i>Input the URL (host name or IP address of</i>

	website, like <a href="http://www.blocked-site.com">http://www.blocked-site.com</a> or <a href="http://11.22.33.44">http://11.22.33.44</a> ), or the keyword which is contained in URL (like pornography, cartoon, stock, or anything).
<i>Add</i>	Click 'Add' button to add the URL / keyword to the URL / Keyword filtering table.
<i>Reset</i>	Click 'Reset' to remove the value you inputted in URL/Keyword field.

All existing URLs will be displayed in 'Current URL Blocking Table':

Current URL Blocking Table:		
NO.	URL/Keyword	Select
1	www.playboy.com	<input type="checkbox"/>

If you want to delete a specific URL/Keyword entry, check the 'select' box of the MAC address you want to delete, then click 'Delete Selected' button. (You can select more than one MAC addresses). If you want to delete all URL/Keyword listed here, please click 'Delete All' button, or you can also click 'Reset' button to unselect all URL/Keywords.

When you finished with the settings in this page, you can click 'Apply' button to save changes you made in this page, or you can click 'Cancel' to discard changes. After you click 'Apply' button, you'll see the following messages:

**Save setting successfully!**

Please press APPLY button to restart the system for changes to take effect.

Please click 'Apply' to save changes you made and restart the broadband router, this requires about 30 seconds and the broadband router will stop

responding (this is normal and is not malfunction). You can reconnect to this broadband router and continue on other settings later.

### 3-5-2-3-3 DoS

Denial of Service (DoS) is a common attack measure, by transmitting a great amount of data or request to your Internet IP address and server, the Internet connection will become very slow, and server may stop responding because it is not capable to handle too much traffics.

This router has a built-in DoS attack prevention mechanism; when you activate it, the router will stop the DoS attack for you:

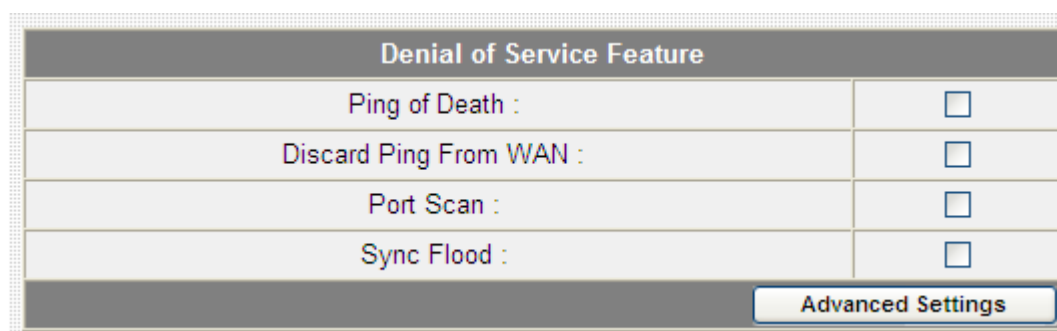

Denial of Service Feature	
Ping of Death :	<input type="checkbox"/>
Discard Ping From WAN :	<input type="checkbox"/>
Port Scan :	<input type="checkbox"/>
Sync Flood :	<input type="checkbox"/>

[Advanced Settings](#)

Here lists four kinds of DoS attacks, please select the type of DoS attack you wish this broadband router to protect, and you can select multiple types of attacks.

The descriptions of every DoS attack is listed below:

Item Name	Description
<i>Ping of Death</i>	<i>Ping of Death is a special packet, and it will cause certain computer to stop responding. Check this box and the router will filter this kind of packet out.</i>
<i>Discard Ping From WAN</i>	<i>Ping is a common and useful tool to know the connection status of a specified remote network device, but some malicious intruder will try to fill your network bandwidth with a lot of PING request data packet, to make your internet connection become very slow, even unusable. Check this box and the router will ignore all inbound PING request, but when you activate this function, you will not be able to</i>

	<i>ping your own router from internet, too.</i>
<i>Port Scan</i>	<i>Some malicious intruder will try to use a 'port scanner' to know how many ports of your Internet IP address are open, and they can collect a lot of valuable information by doing so. Check this box and the router will block all traffics which are trying to scan your Internet IP address.</i>
<i>Sync Flood</i>	<i>This is another kind of attack, which uses a lot of fake connection request to consume the memory of your server, and try to make your server become unusable. Check this box and the router will filter this kind of traffic out.</i>

If you need to specify the details of every DoS attack, please click 'Advanced Settings' button, and the following settings will appear:

**Denial of Service Feature**

Ping of Death : 5 Packet(S) Per Second Burst

Discard Ping From WAN :

Port Scan :

- NMAP FIN / URG / PSH
- Xmas tree
- Another Xmas tree
- Null scan
- SYN / RST
- SYN / FIN
- SYN (only unreachable port)

Sync Flood : 30 Packet(S) Per Second Burst

Apply Cancel

The descriptions of every DoS attack is listed below:

Item Name	Description
<i>Ping of Death</i>	<i>Set the threshold of when this DoS prevention mechanism will be activated. Please check the</i>

	<i>box of Ping of Death, and input the frequency of threshold (how many packets per second, minute, or hour), you can also input the 'Burst' value, which means when this number of 'Ping of Death' packet is received in very short time, this DoS prevention mechanism will be activated.</i>
<i>Discard Ping From WAN</i>	<i>Check the box to activate this DoS prevention mechanism.</i>
<i>Port Scan</i>	<i>Many kind of port scan methods are listed here, please check one or more DoS attack methods you want to prevent.</i>
<i>Sync Flood</i>	<i>Like Ping of Death, you can set the threshold of when this DoS prevention mechanism will be activated.</i>

When you finished with the settings in this page, you can click 'Apply' button to save changes you made in this page, or you can click 'Cancel' to discard changes. After you click 'Apply' button, you'll see the following messages:

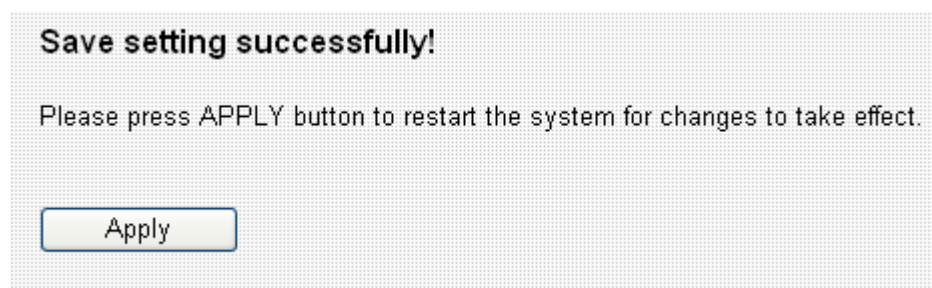

Please click 'Apply' to save changes you made and restart the broadband router, this requires about 30 seconds and the broadband router will stop responding (this is normal and is not malfunction). You can reconnect to this broadband router and continue on other settings later.

### 3-5-2-4 DDNS

DDNS (Dynamic DNS) is a IP-to-Hostname mapping service for those Internet users who don't have a static (fixed) IP address. It will be a problem when such user wants to provide services to other users on Internet, because their IP address will vary every time when connected to Internet, and other user will not be able to know the IP address they're using at a certain time.

This router supports DDNS service of following service providers:

3322 (<http://www.3322.org/>)

DHS (<http://www.dhs.org>)

DynDNS (<http://www.dyndns.org/>)

ODS (<http://ods.org>)

TZO (<http://www.tzo.com/>)

GnuDIP (<http://gnudip2.sourceforge.net/>)

DyNS (<http://www.dyns.cx/>)

ZoneEdit (<http://www.zoneedit.com>)

DHIS (<http://www.dhis.org/>)

CyberGate (<http://cybergate.planex.co.jp/ddns/>)

Please go to one of DDNS service provider's webpage listed above, and get a free DDNS account by the instructions given on their webpage. After that, you can use the DDNS page to setup DDNS parameters to use DDNS service:

<b>Dynamic DNS :</b>	<input checked="" type="radio"/> Enabled <input type="radio"/> Disabled
<b>Provider :</b>	CyberGate <input type="button" value="v"/>
<b>Domain Name :</b>	<input type="text"/>
<b>Account / E-Mail :</b>	<input type="text"/>
<b>Password / Key :</b>	<input type="text"/>
<input type="button" value="Apply"/> <input type="button" value="Cancel"/>	

Here are descriptions of every setup items:

Item Name	Description
<i>Dynamic DNS</i>	<i>If you want to enable DDNS function, please select 'Enabled'; otherwise please select 'Disabled'</i>
<i>Provider</i>	<i>Select your DDNS service provider here.</i>
<i>Domain Name</i>	<i>Input the domain name you've obtained from DDNS service provider.</i>
<i>Account / E-Mail</i>	<i>Input account or email of DDNS registration.</i>
<i>Password / Key</i>	<i>Input DDNS service password or key.</i>

*If your DDNS provider is 'DHIS', the settings will be different:*

Here are descriptions of every setup items:

Item Name	Description
HostID	Please input the HostID you applied during DHIS registration.
ISAddr	Please input the ISAddr you applied during DHIS registration.
Authentication Type	Please select the DHIS user authentication type from dropdown menu: password or QRC.
HostPass	Please input the HostID you applied during DHIS registration.  (This field will appear only when

	authentication type is password).
AuthP / AuthQ	Please input the AuthP/AuthQ you applied during DHIS registration.  (This field will appear only when authentication type is QRC).

When you finished with the settings in this page, you can click 'Apply' button to save changes you made in this page, or you can click 'Cancel' to discard changes. After you click 'Apply' button, you'll see the following messages:

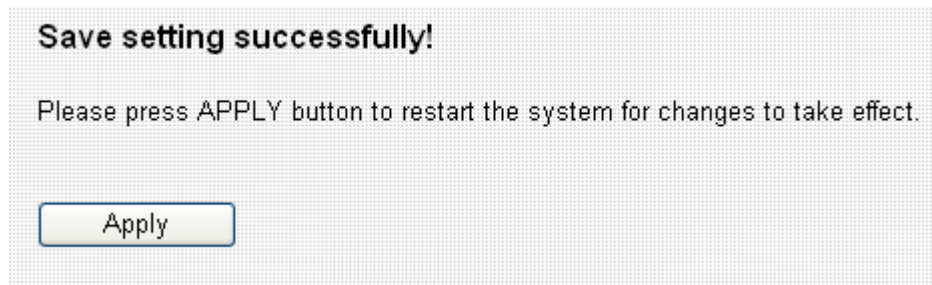

Please click 'Apply' to save changes you made and restart the broadband router, this requires about 30 seconds and the broadband router will stop responding (this is normal and is not malfunction). You can reconnect to this broadband router and continue on other settings later.

### 3-5-2-5 Port Forwarding

This function allows you to redirect a single port or consecutive ports of Internet IP address to the same port of the IP address on local network. The port number(s) of Internet IP address and private IP address (the IP address on local network) must be the same.

If the port number of Internet IP address and private IP address is different, please use 'Virtual Server' function.

The port forwarding setting page looks like this:

Enable Port Forwarding

Private IP	Computer name	Type	Port Range	Comment
<input type="text"/>	<< -----Select----- >>	Both	<input type="text"/> - <input type="text"/>	<input type="text"/>

Add Reset

Current Port Forwarding Table:

NO.	Computer name	Private IP	Type	Port Range	Comment	Select
1	OFFLINE	192.168.98.197	TCP	1997-2000	Office PC 197	<input type="checkbox"/>

Delete Selected Delete All Reset

Apply Cancel

Here are descriptions of every setup items:

Item Name	Description
<i>Enable Port Forwarding</i>	<i>Check this box to enable port forwarding, and uncheck this box to disable port forwarding.</i>
<i>Private IP</i>	<i>Input the IP address of the computer on local network which provides internet service.</i>
<i>Computer name</i>	<i>All computer names found by this broadband router on local network will be listed here. You can select the computer name and click '&lt;&lt;' button to add selected computer's IP address to 'Private IP' field.</i>  <i>Please note that this list may not be able to list all computers on your local network.</i>

<i>Type</i>	<i>Select the type of connection, TCP or UDP. If you're not sure, please select 'Both'.</i>
<i>Port Range</i>	<i>Input the starting port number in the left field, and input the ending port number in the right field. If you only want to redirect a single port number, just fill the port number in the left field.</i>
<i>Comment</i>	<i>Please input any text to describe this mapping, up to 16 alphanumerical characters.</i>
<i>Add</i>	<i>Add the mapping to port forwarding table.</i>
<i>Reset</i>	<i>Remove all inputted values.</i>

All existing URLs will be displayed in 'Current URL Blocking Table':

Current Port Forwarding Table:

NO.	Computer name	Private IP	Type	Port Range	Comment	Select
1	OFFLINE	192.168.98.197	TCP	1997-2000	Office PC 197	<input type="checkbox"/>

If you want to delete a specific port forwarding entry, check the 'select' box of the port forwarding entry you want to delete, then click 'Delete Selected' button. (You can select more than one port forwarding entries). If you want to delete all port forwarding entries listed here, please click 'Delete All' button or you can also click 'Reset' button to unselect all port forwarding entries.

When you finished with the settings in this page, you can click 'Apply' button to save changes you made in this page, or you can click 'Cancel' to discard changes. After you click 'Apply' button, you'll see the following messages:

**Save setting successfully!**

Please press APPLY button to restart the system for changes to take effect.

Apply

Please click 'Apply' to save changes you made and restart the broadband router, this requires about 30 seconds and the broadband router will stop responding (this is normal and is not malfunction). You can reconnect to this broadband router and continue on other settings later.

### 3-5-2-6 DMZ

Demilitarized Zone (DMZ) is a special area in your local network. This area resides in local network, and all computers in this area uses private IP address, too. But these private IP addresses are mapped to a certain Internet IP address, so other people on Internet can fully access those computers in DMZ.

The DMZ setting page looks like this:

Here are descriptions of every setup items:

Item Name	Description
<i>Enable DMZ</i>	<i>Check this box to enable DMZ function, uncheck this box to disable DMZ function.</i>
<i>Public IP address</i>	<i>You can select 'Dynamic IP' or 'Static IP' here. If you select 'Dynamic IP', you have to select an Internet connection session from dropdown menu; if you select 'Static IP', please input the IP address that you want to map to a specific private IP address.</i>
<i>Client PC IP address</i>	<i>Please input the private IP address that the Internet IP address will be mapped to.</i>
<i>Type</i>	<i>Select the type of connection, TCP or UDP. If</i>

	<i>you're not sure, please select 'Both'.</i>
<i>Port Range</i>	<i>Input the starting port number in the left field, and input the ending port number in the right field. If you only want to redirect a single port number, just fill the port number in the left field.</i>
<i>Comment</i>	<i>Please input any text to describe this mapping, up to 16 alphanumerical characters.</i>
<i>Add</i>	<i>Add the mapping to port forwarding table.</i>
<i>Reset</i>	<i>Remove all inputted values.</i>

NOTE: Please note that every public IP address can be mapped to a single Client PC IP address only.

All existing DMZ entries will be displayed in 'Current DMZ Table':

Current DMZ Table :				
NO.	Computer name	Public IP address	Client PC IP address	Select
1	OFFLINE	---	192.168.98.30	<input type="checkbox"/>

If you want to delete a specific DMZ entry, check the 'select' box of the DMZ entry you want to delete, then click 'Delete Selected' button. (You can select more than one DMZ entries). If you want to delete all DMZ entries listed here, please click 'Delete All' button or you can also click 'Reset' button to unselect all DMZ entries.

When you finished with the settings in this page, you can click 'Apply' button to save changes you made in this page, or you can click 'Cancel' to discard changes. After you click 'Apply' button, you'll see the following messages:

**Save setting successfully!**

Please press APPLY button to restart the system for changes to take effect.

Apply

Please click 'Apply' to save changes you made and restart the broadband router, this requires about 30 seconds and the broadband router will stop responding (this is normal and is not malfunction). You can reconnect to this broadband router and continue on other settings later.

## Chapter IV EZ View

Many network devices like printer, IP camera, and multi-media adapters support UPnP (Universal PnP) function. Those UPnP-compatible devices can communicate with each other, and make appropriate configurations.

This broadband router is capable to scan the local network and find all UPnP-compatible devices out, you can get a list of all UPnP devices on network, and you can connect to the administration interface of these devices from web interface directly. EZView also helps you to set the name and IP address of UPnP-compatible network devices, and control its bandwidth usage. You can also set special network functions like DMZ and port forwarding for a specific UPnP-compatible devices.

To use EZ View, please follow the following instructions:

1. click 'EZ View' button from main menu:



2. A pop-up window (or new web browser tab) will appear to show that broadband router is scanning for UPnP devices on network, please wait for 30 seconds until 'OK' button appears. Click 'OK' button to continue.

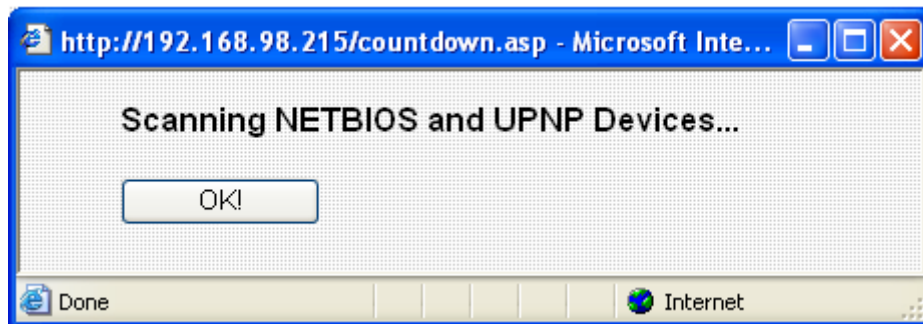
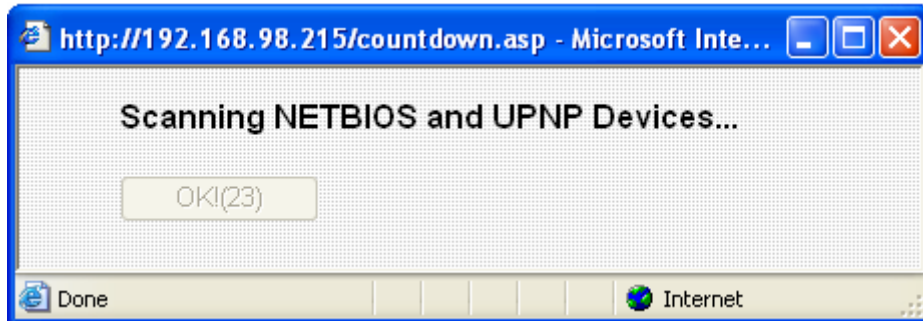

3. All UPnP-compatible devices found on the network will be listed here, with the category it belongs to and its name. (For network devices not manufactured by Edimax, or earlier non-PnP Edimax products, the category and name will not be able to displayed).

**Online Devices**

Device Name		Device IP	
?	N/A	192.168.98.212	<input type="button" value="Config"/>
?	N/A	192.168.98.213	<input type="button" value="Config"/>

**Offline Devices**

Device Name		Device IP	
---	---	---	---

You can click 'Config' button to connect to the web administration interface of the network device, as shown below. (The following picture is an example of connecting to an IP camera, you can input its username and password to login).

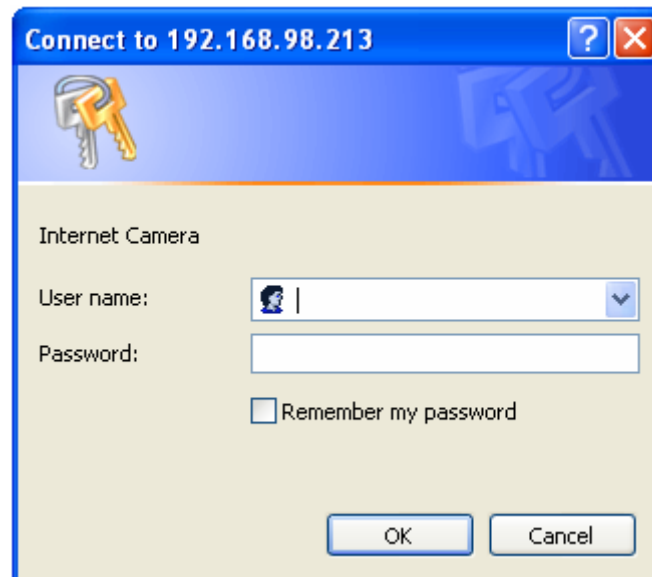





If you want to rescan UPnP devices, click 'Refresh' button.

If you need to set the detailed information of UPnP devices, please click 'Advanced' button, and the following settings will appear:

Online Devices										
Add	DEL	Device Name	Device IP	Bandwidth Control			DMZ	Port Forwarding		
				Download	Upload	Block				
<input type="checkbox"/>		?	<input type="text" value=""/>	192.168.98.212	<input type="button" value="Config"/>	High	High	<input type="button" value="Set"/>	<input type="radio"/>	<input type="button" value="Set"/> <input type="button" value="View"/>
<input type="checkbox"/>		?	<input type="text" value=""/>	192.168.98.213	<input type="button" value="Config"/>	High	High	<input type="button" value="Set"/>	<input type="radio"/>	<input type="button" value="Set"/> <input type="button" value="View"/>

You can click '?' icon and a drop-down list will shown, then you can select an icon for the network device you selected. For example, if the network device you selected is a computer, you can use the person icon to represent it.

<input checked="" type="checkbox"/>			<input type="text" value="OBMTEST"/>	192.168.2.100
<input type="checkbox"/>			<input type="text" value="IC-3010WG"/>	192.168.2.101

Online Devices			
<input type="button" value="Advance"/>			
Device Name		Device IP	
	OBMTEST	192.168.2.100	<input type="button" value="Config"/>
	IC-3010WG	192.168.2.101	<input type="button" value="Config"/>

Online Devices										
Add	DEL	Device Name	Device IP	Bandwidth Control			DMZ	Port Forwarding		
				Download	Upload	Block				
<input checked="" type="checkbox"/>			<input type="text" value="OBMTEST"/>	192.168.2.100	<input type="button" value="Config"/>	High	High	<input type="button" value="Set"/>	<input type="radio"/>	<input type="button" value="Set"/> <input type="button" value="View"/>
<input type="checkbox"/>			<input type="text" value="IC-3010WG"/>	192.168.2.101	<input type="button" value="Config"/>	High	High	<input type="button" value="Set"/>	<input type="radio"/>	<input type="button" value="Set"/> <input type="button" value="View"/>

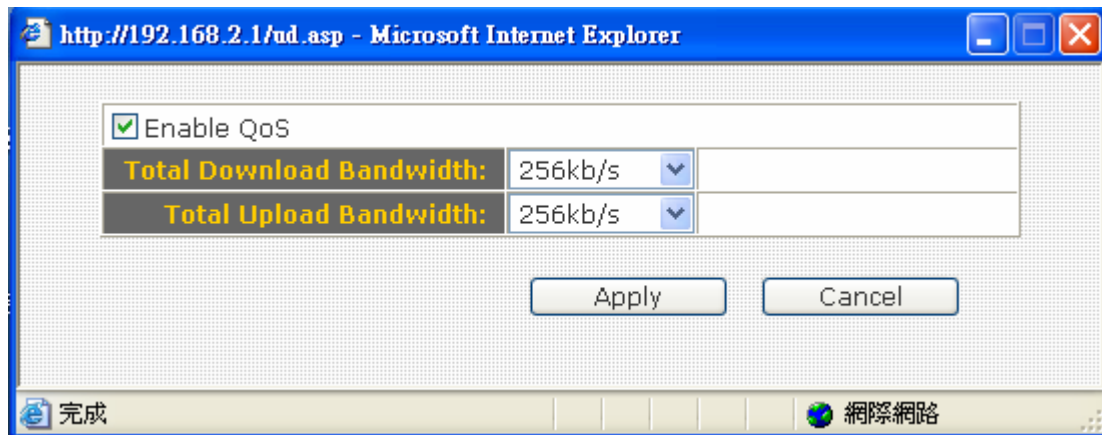

Here are descriptions of every setup items:

Item Name	Description
<i>Add</i>	<i>Click this button to add a network device, and you can set detailed network information like name and IP address for it. Click 'Apply' button to save changes and new setting will take effect until next login.</i>
<i>DEL</i>	<i>Click this button to delete all settings assigned to the network device.</i>
<i>Device Name</i>	<i>You can give this device a name as memory aid. Also, if the type of UPnP device is not identified by this broadband router, a question mark (?) will appear to the left of device's name. You can click the question mark, several icons will appear and you can pick an icon that is able to represents this device.</i>
<i>Config</i>	<i>Click 'Config' button to connect to the web configuration interface of UPnP device.</i>
<i>Upload / Download</i>	<p><i>Please click red dot</i> </p> <p><i>(located at the right of 'Upload'), and a new pop-up window will be shown. Please check 'Enable QoS' box to enable QoS bandwidth control function for this device, and select the upload / download bandwidth you wish to assign to this device from dropdown list.</i></p>
<i>Block</i>	<i>You can block this device so it will not be able</i>

	<p><i>to access the network at certain time period. Click 'Set' button and a new window will appear with three time-selection options:</i></p> <p><i>No Block: Do not block this UPnP device.</i></p> <p><i>Time Interval: This UPnP device will be blocked during the time period you specified. Please input 'from' and 'to' hour in two respective fields of this item by 24 hours format.</i></p> <p><i>Always: This UPnP device will be blocked permanently.</i></p> <p><i>Click 'Apply' to save changes you made, or click 'Cancel' to close pop-up window and discard changes.</i></p>
<p><i>DMZ</i></p>	<p><i>Select 'DMZ' to set this device as a DMZ server.</i></p> <p><i>Please note that you can only set one DMZ server at the same time.</i></p>
<p><i>Port Forwarding</i></p>	<p><i>You can set the port-forwarding rules for this device. Click 'Set' and a new pop-up window will shown, you can set up to 5 sets of port-forwarding rules for this device. You can click 'Apply' in port-forwarding setting window to save changes, or click 'Cancel' to close window and discard changes.</i></p> <p><i>You can also click 'View' to view current port-forwarding rules for this device.</i></p>

You can click 'Refresh' button to rescan all UPnP-compatible devices on network,

When you finished with the settings in this page, you can click 'Apply' button to save changes you made in this page, or you can click 'Cancel' to discard changes. After you click 'Apply' button, you'll see the following messages:

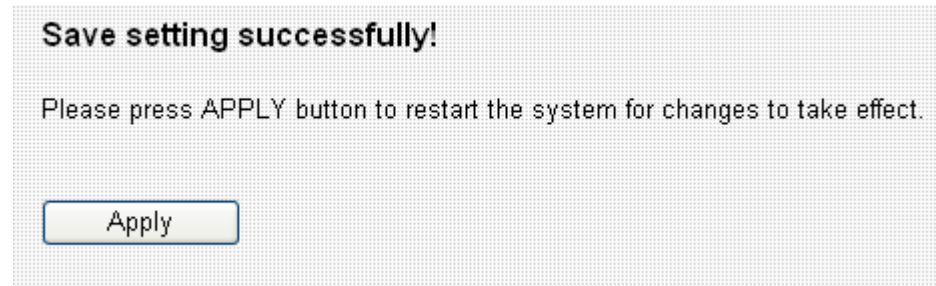

**Save setting successfully!**

Please press APPLY button to restart the system for changes to take effect.

Apply

Please click 'Apply' to save changes you made and restart the broadband router, this requires about 30 seconds and the broadband router will stop responding (this is normal and is not malfunction). You can reconnect to this broadband router and continue on other settings later.

## Chapter V: Status

In this menu, you can check the operation status of this broadband router. To view the status, follow the following instructions:

1. Click 'Status' button from main menu:

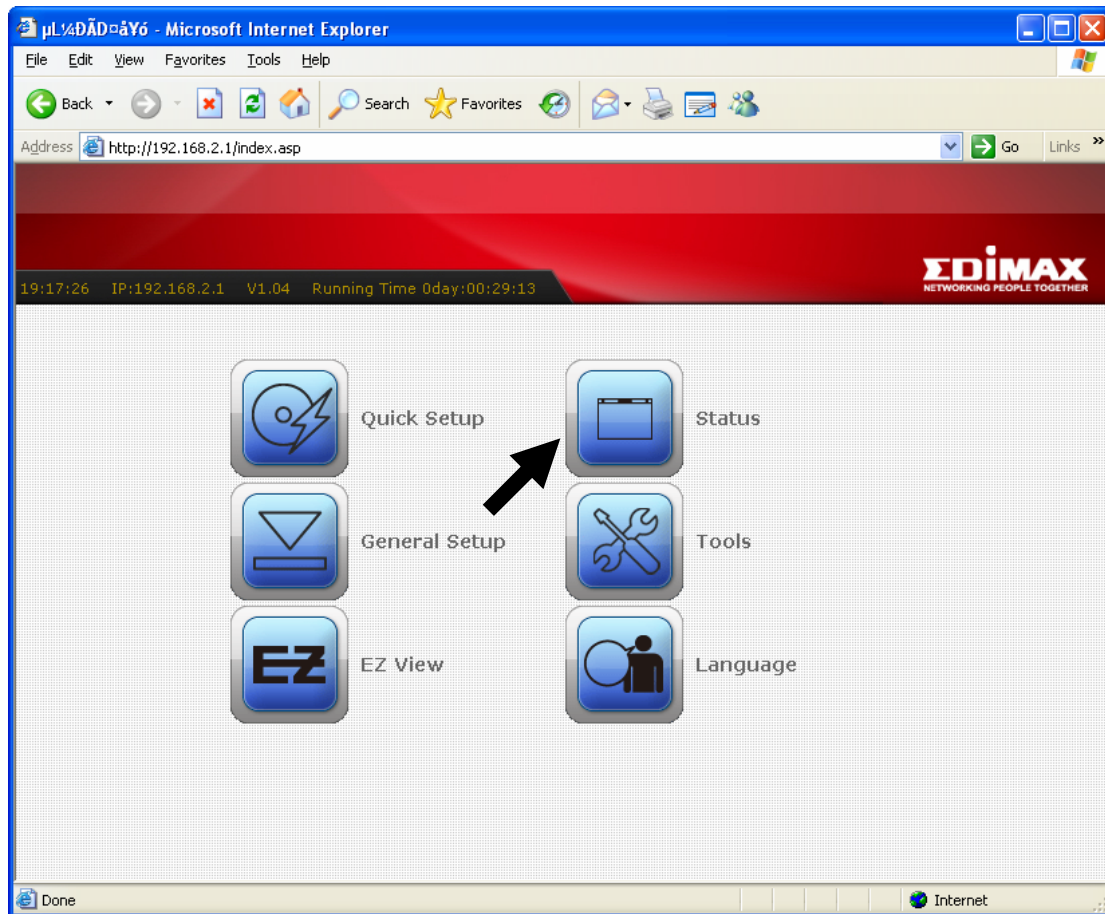

2. The basic system information will be shown:

System	
Model	Wireless Router
Up time	0day:20h:8m:47s
Hardware Version	Rev. A
Boot Code Version	1.0
Runtime Code Version	1.04

You can check the system uptime and firmware version of this broadband router. If you need detailed information about Internet connection or system usage log, please choose one of them and click 'Apply'. If you want to go back to previous page, please click 'Previous'.

<input type="radio"/>	<b>Internet Connection</b>	View the current internet connection status and related information.
<input type="radio"/>	<b>Device Status</b>	View the current setting status of this device.
<input type="radio"/>	<b>System Log</b>	View the system operation information. You can see the system start up time, connection process...etc. here.
<input type="radio"/>	<b>Security Log</b>	View any attempts that have been made to illegally gain access to your network.
<input type="radio"/>	<b>Active DHCP Client</b>	This table shows the assigned IP address, MAC address and time expired for each DHCP leased client.
<input type="radio"/>	<b>Statistics</b>	This page shows the packet counters for transmission and reception regarding to networks.

## 5-1 Internet Connection

This page shows the current status of Internet connection.

<b>Attain IP Protocol :</b>	Fixed IP connect
<b>IP Address :</b>	172.1.1.1
<b>Subnet Mask :</b>	255.255.0.0
<b>Default Gateway :</b>	172.1.1.254
<b>MAC Address :</b>	00:11:22:33:44:56
<b>Primary DNS :</b>	168.95.1.1
<b>Secondary DNS :</b>	0.0.0.0

## 5-2 Device Status

This page shows current wireless LAN and wired LAN configuration.

Wireless Configuration	
<b>Mode</b>	AP
<b>ESSID</b>	EDIMAX
<b>Channel Number</b>	7
<b>Security</b>	WPA pre-shared key

LAN Configuration	
<b>IP Address</b>	192.168.98.215
<b>Subnet Mask</b>	255.255.255.0
<b>DHCP Server</b>	Disable
<b>MAC Address</b>	00:0c:29:e0:3f:f2

## 5-3 System Log

This page shows all logged system information. You can use scroll bar to view the logs, or click 'Save' to download the log file to your computer. You can also click 'Clear' to remove all logs, or click 'Refresh' to reload logs.

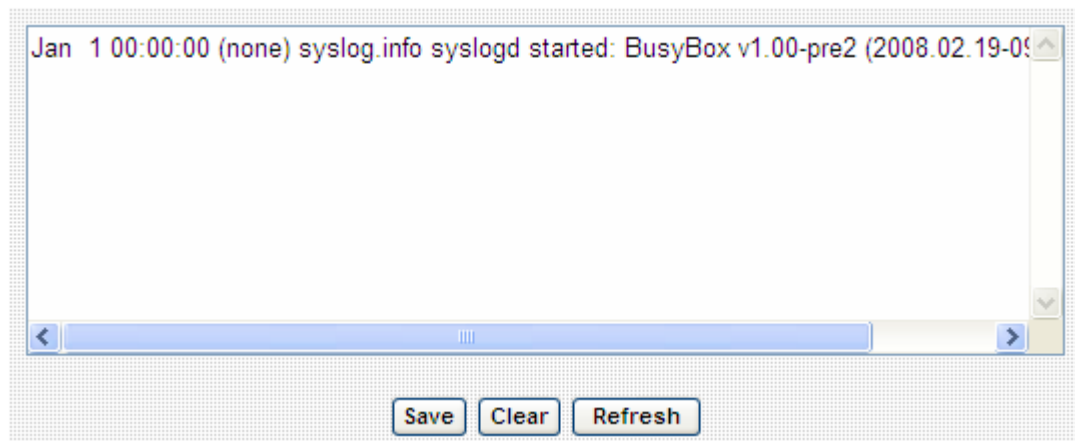

## 5-4 Security Log

This page shows all logged security-related information. You can use scroll bar to view the logs, or click 'Save' to download the log file to your computer. You can also click 'Clear' to remove all logs, or click 'Refresh' to reload logs.

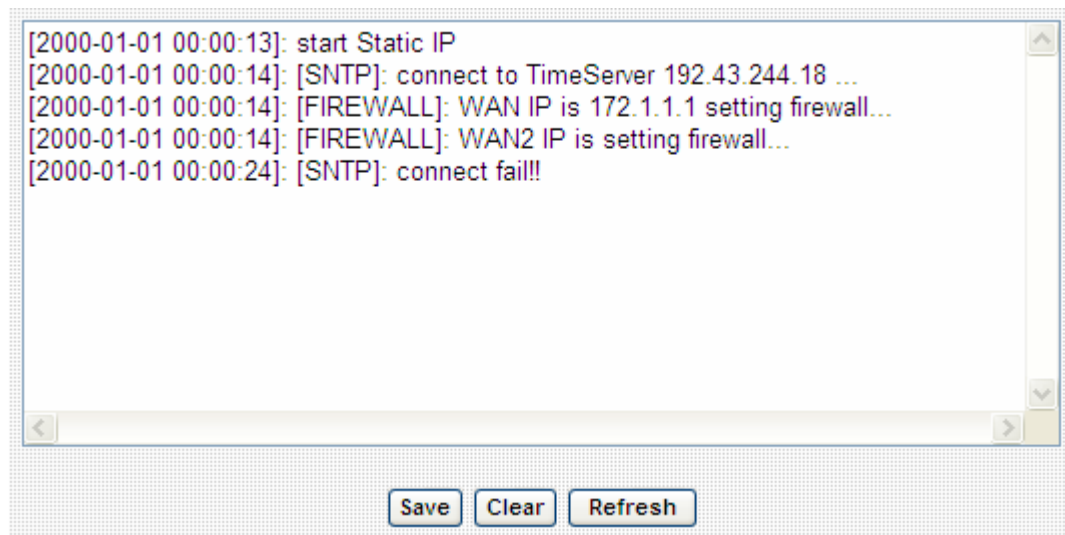

## 5-5 Active DHCP Client

This page shows all current DHCP clients. You can click 'Refresh' to reload the list.

IP Address	MAC Address	Time Expired(s)
None	---	---

Refresh

## 5-6 Statistics

This page shows the statistical information of network interfaces of this broadband router, and the total system uptime.

Wireless LAN	<i>Sent Packets</i>	3950
	<i>Received Packets</i>	75148
Ethernet LAN	<i>Sent Packets</i>	14969
	<i>Received Packets</i>	112690
Ethernet WAN	<i>Sent Packets</i>	31844
	<i>Received Packets</i>	0
Running Time	<i>0day:22:13:26</i>	<input type="button" value="Restart"/>

## Chapter VI : Tools

This broadband router comes with several tools that will help you to manage the configuration of broadband router, upgrade the firmware, and restart the broadband router.

To use these tools, follow the following instructions:

1. Click 'Tools' button from main menu:

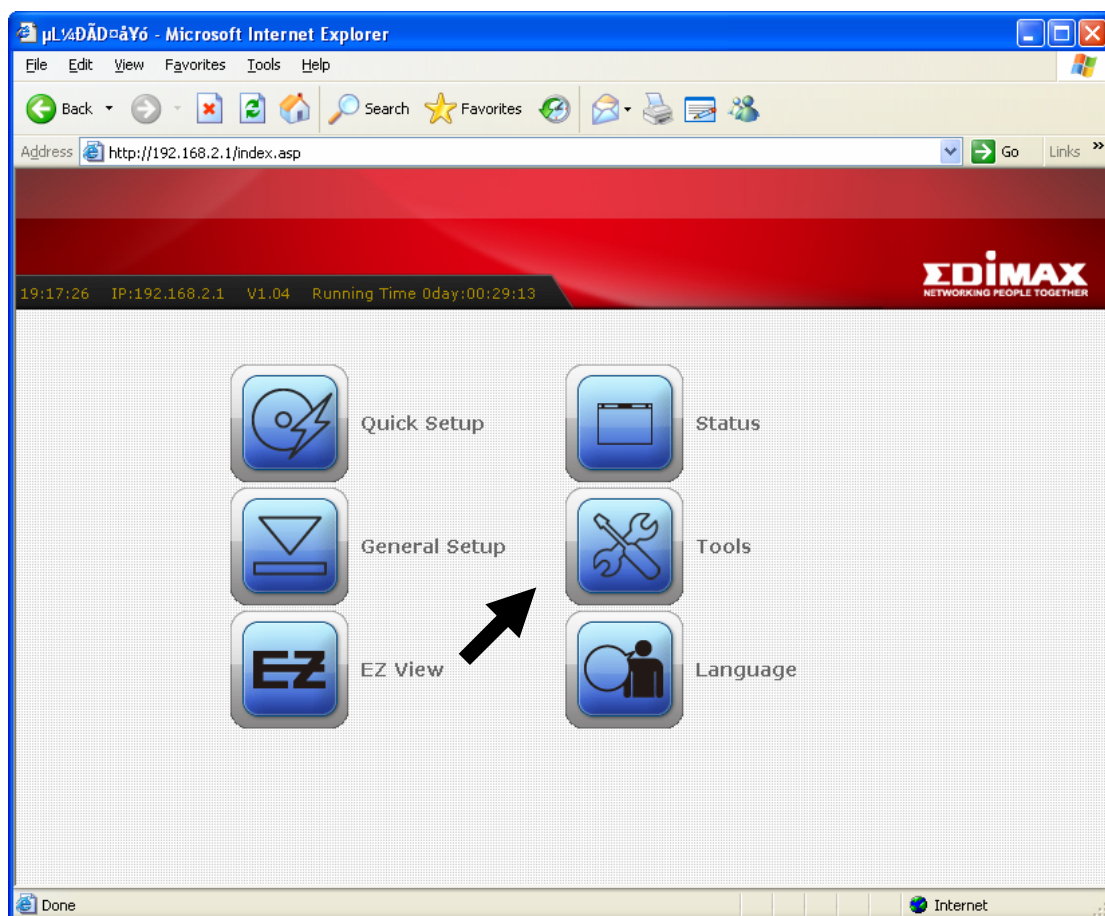

2. The list of tools will appear:

<input type="radio"/>	<b>Configuration Tools</b>	Use the "Backup" tool to save the Broadband router's current configurations to a file named "config.bin". You can then use the "Restore" tool to restore the saved configuration to the Broadband router. Alternatively, you can use the "Restore to Factory Default" tool to force the Broadband router to perform System Reset and restore the original factory settings.
<input type="radio"/>	<b>Firmware Upgrade</b>	This tool allows you to upgrade the Broadband router's system firmware. Enter the path and name of the upgrade file and then click the APPLY button below. You will be prompted to confirm the upgrade. The system will automatically reboot the router after you finished the firmware upgrade process. If you don't complete the firmware upgrade process in the "next" step, you have to reboot the router.
<input type="radio"/>	<b>Restart</b>	In the event that the system stops responding correctly or stops functioning, you can perform a Reset. Your settings will not be changed. To perform the reset, click on the APPLY button below. You will be asked to confirm your decision. The Reset will be complete when the LED Power light stops blinking.

Please select the tool you wish to use, then click 'Apply' button. If you wish to go back to previous page, click 'Previous' button.

## 6-1 Configuration Tools

In this page, you can backup and restore current system configuration, and reset all settings to factory default value.

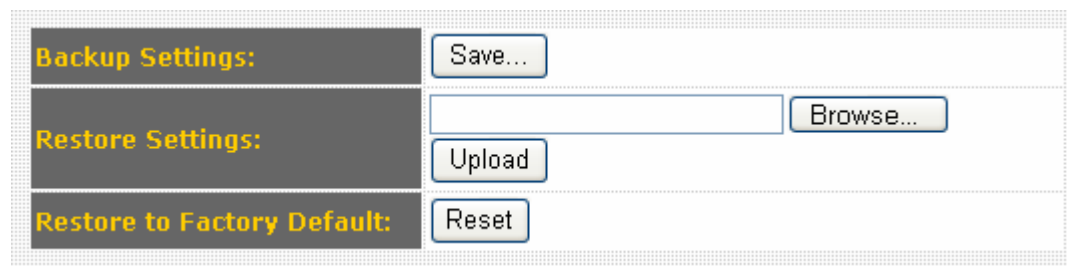

The screenshot shows a web interface with three main sections:

- Backup Settings:** A button labeled "Save..." is positioned to the right of the label.
- Restore Settings:** A text input field is followed by a "Browse..." button. Below the input field is an "Upload" button.
- Restore to Factory Default:** A "Reset" button is positioned to the right of the label.

Here are descriptions of every setup items:

Item Name	Description
<i>Backup Settings</i>	<i>Click 'Save...' button to download the current configuration as 'config.bin' file. Save this file on your computer to keep current configuration. If you want to keep more than one version of configuration file, please rename the configuration file to another name.</i>
<i>Restore Settings</i>	<i>Click 'Browse...' button to select a previously-saved configuration file from your computer, then click 'Upload' to upload the configuration file to broadband router, and the configuration of broadband router will be replaced by the content of uploaded configuration file.</i>
<i>Restore to Factory Default</i>	<i>Click 'Reset' button to restore the settings of the broadband router to factory default value. A pop-up message window will appear and ask you to confirm the reset.</i>

## 6-2 Firmware Upgrade

New firmware releases will provide new functions to this broadband router, and you can use firmware upgrade function to upgrade the firmware to new version.

*NOTE: It's recommended to use wired Ethernet connection to upload the firmware file, please refrain from using wireless connection to upload the firmware file. Also, please do not switch the broadband router or computer you used to upload the firmware file off during firmware upgrade. This will cause broadband router become malfunction and unusable.*

Please download the firmware file from our company's website and save it on your computer, and use firmware upgrade function to upgrade firmware:



Please click 'Browse...' button to select the firmware file saved on your computer, then click 'Apply' button to start firmware upload. The broadband router will restart after file upload is successful, and all settings will be lost. Please use default IP address (192.168.2.1) to connect to the broadband router and set every settings again.

## 6-3 Restart

If you found that the broadband router is not functioning correctly, or responding slowly then usual, you can use this function to restart the broadband router, and this may correct the problem.

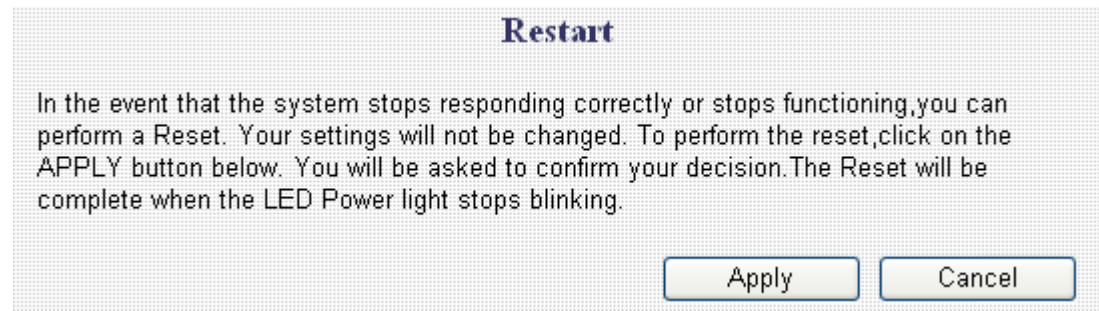

Click 'Apply' button to restart the broadband router. You'll be prompted to confirm the restart, click 'OK' to restart the broadband router.

## Chapter VII : Language

This broadband router's web-based user interface supports several languages in the future .We will release English version at first, and add others step by step. You can view website <http://www.edimax.com> to check new firmware. You can change the display language by click 'Language' button in main menu.

To change the display language, follow the following instructions:

1. Click 'Language' button from main menu:

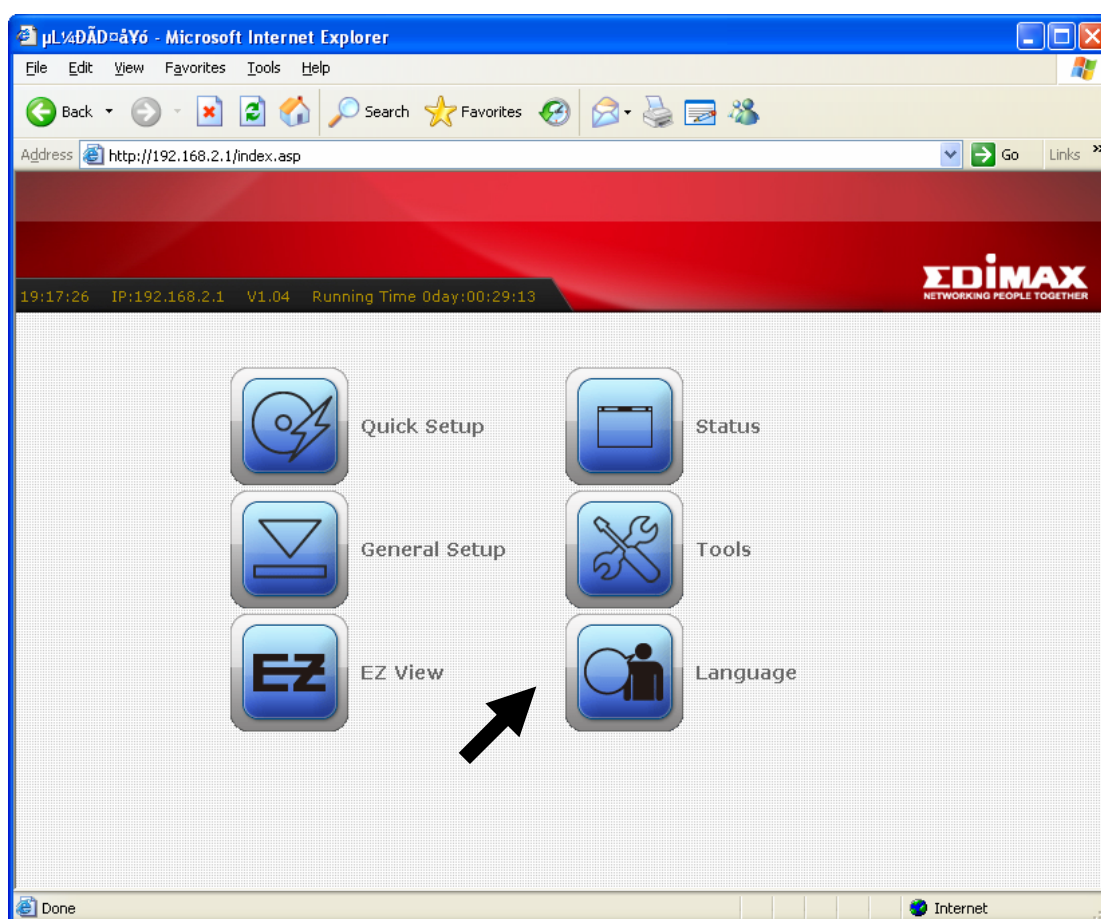

#### **Headquarters**

Edimax Technology co., Ltd  
NO. 3, Wu-Chuan 3rd RD  
Wu-Ku-Industrial Park  
Taipei Hsien, Taiwan. R.O.C.  
TEL : +886-2-77396888  
FAX : +886-2-77396887  
e-mail : sales@edimax.com.tw

#### **European Headquarters**

Edimax Technology Europe B.V.  
Nijverheidsweg 25 5683 CJ Best  
The Netherlands  
TEL : +31-499-377344  
FAX : +31-499-372647  
e-mail : sales@edimax.nl

#### **USA Office**

Edimax Computer Company  
3350 Scott Blvd., Bldg.15  
Santa Clara, CA 95054, USA  
TEL : +1-408-4961105  
FAX : +1-408-9801530  
e-mail : sales@edimax.com

#### **Poland Office**

Edimax Technology Poland. Sp. Z o.o.  
ul. Postepu 14, 02-676 Warsaw, Poland  
TEL : +48-22-6079480  
FAX : +48-22-6079481  
e-mail : sales@edimax.pl

#### **United Kingdom Office**

Edimax Technology (UK) Ltd.  
Suite 378 Silbury Court, Silbury Boulevard  
Milton Keynes MK9 2AF  
TEL : +44-845-1238307  
FAX : +44-845-1238306  
e-mail : info@edimax.co.uk

#### **Latin America Office**

Edimax Latin America Inc.  
2954 NW 72 Ave. Miami, FL 33122. USA.  
TEL : +1-786-8458099  
FAX : +1-786-3318490  
e-mail : sales\_latinamerica@edimax.com

#### **Romania Office**

Edimax Technology Romania  
Bucuresti, str. Splaiul Unirii, nr. 10,  
bl. B5, sc. 1, et. 5, ap.15, sector 4.  
TEL : +40-31-4250126  
FAX : +40-31-4250125  
e-mail : sales@edimax.ro

#### **Germany Office**

Edimax Technology Europe BV  
Hans-Boeckler-Str. 13,  
47877 Willich Germany  
TEL : +49-215488-2831  
FAX : +49-215488-2834  
e-mail : sales@edimax-de.eu

#### **China Office**

Beijing Edimax Science & Technology Co., Ltd.  
17#1708, IDEAL Plaza, NO.111,  
ZhiChun Road, HaiDian District,  
Beijing, China  
TEL : +8610-82665815  
FAX : +8610-82665795  
e-mail : sales@edimax.com.cn

#### **Russia Office**

Edimax Technology Russia  
Fridriha Ehgelsa str., 75, bld. 3,  
105082 Moscow, Russia  
TEL : +7-495-9210239  
FAX : +7-495-9210239  
e-mail : sales@edimax.pl

#### **France Office**

EDIMAX Technology Europe B.V. FRANCE  
Marne-la-Vallée 6, rue de la Mare Blanche  
77186, NOISIEL, FRANCE  
TEL : +33 (0)1 60 53 56 80  
FAX : +33 (0)1 60 53 56 89  
e-mail : sales@edimax.fr

  
NETWORKING PEOPLE TOGETHER

[www.edimax.com](http://www.edimax.com)