



Broadband Router

Broadband Router

User's Manual

| | |
|---|-----------|
| Introduction..... | 4 |
| Features..... | 4 |
| Minimum Requirements | 4 |
| Package Content | 4 |
| Note | 4 |
| Get to know the Broadband Router | 5 |
| Back Panel | 5 |
| Front Panel | 6 |
| Setup Diagram..... | 7 |
| Getting started..... | 7 |
| Chapter 1 | 16 |
| Quick Setup | 16 |
| Step 1) Time Zone | 16 |
| Step 2) Broadband Type..... | 17 |
| 1.1 Cable Modem | 18 |
| 1.2 Fixed-IP xDSL..... | 18 |
| 1.3 PPPoE | 19 |
| 1.4 PPTP | 21 |
| Chapter 2 | 24 |
| General Settings | 24 |
| 2.1 System | 25 |
| 2.1.1 Time Zone | 26 |
| 2.1.2 Password Settings | 27 |
| 2.1.3 Remote Management..... | 28 |
| 2.2 WAN..... | 29 |
| 2.2.1 Dynamic IP | 30 |
| 2.2.2 Static IP Address..... | 30 |
| 2.2.3 PPPoE (PPP over Ethernet)..... | 30 |
| 2.2.4 PPTP | 30 |
| 2.2.5 L2TP..... | 31 |
| 2.2.6 Telstra Big Pond..... | 32 |
| 2.2.7 DNS | 33 |
| 2.2.8 DDNS..... | 34 |
| 2.3 LAN | 35 |
| 2.4 NAT | 37 |
| 2.4.1 Port Forwarding | 38 |
| 2.4.2 Virtual Server..... | 39 |
| 2.4.3 Special Applications..... | 42 |
| 2.4.4 ALG Settings | 44 |
| 2.5 Firewall | 45 |
| 2.5.1 Access Control..... | 46 |
| 2.5.2 URL Blocking..... | 51 |
| 2.5.3 Denial of Service (DoS)..... | 52 |
| 2.5.4 DMZ | 52 |
| Chapter 3 | 54 |
| Status..... | 54 |

| | |
|--|-----------|
| 3.1 Status and Information | 55 |
| 3.2 Internet Connection..... | 55 |
| 3.3 Device Status | 56 |
| 3.4 System Log..... | 57 |
| 3.5 Security Log..... | 58 |
| 3.6 Active DHCP Client Table | 59 |
| 3.7 Statistics | 60 |
| Chapter 4 | 62 |
| Tool..... | 62 |
| 4.1 Configuration Tools..... | 62 |
| 4.2 Firmware Upgrade | 63 |
| 4.3 Reset | 64 |
| Chapter 5 | 66 |
| 5.1 Install Print Server Network Driver | 66 |
| 5.2 Add a Network Printer..... | 69 |
| Appendix A | 71 |
| Glossary | 72 |

Introduction

Congratulations on purchasing this Broadband Router. This Broadband Router is a IP Sharing Router that enables multiple users to share the Internet through an ADSL or cable modem. Simply configure your Internet connection settings in the Broadband Router and plug your PC to the LAN port and you're ready to share files and access the Internet. As your network grows, you can connect another hub or switch to the router's LAN ports, allowing you to easily expand your network. It provides a total solution for the Small and Medium-sized Business (SMB) and the Small Office/Home Office (SOHO) markets, giving you an instant network today, and the flexibility to handle tomorrow's expansion and speed, this router provides two USB ports for connecting with USB printer.

Features

- High Internet Access throughput
- Allow multiple users to share a single Internet line
- Supports up to 253 users
- Provides two USB port for connecting with USB printer.
- Internet Access via Cable or xDSL modem
- Access Private LAN Servers from the Public Network
- Equipped with four LAN ports (10/100M) and one WAN port (10/100M)
- Support DHCP (Server/Client) for easy setup
- Support advance features such as: Special Applications, DMZ, Virtual Servers, Access Control, Firewall.
- Allow you to monitor the router's status such as: DHCP Client Log, Security Log and Device/Connection Status
- Easy to use Web-based GUI for configuration and management purposes
- Remote Management allows configuration and upgrades from a remote site (over the Internet)

Minimum Requirements

- One External xDSL (ADSL) or Cable modem with an Ethernet port (RJ-45)
- Network Interface Card (NIC) for each Personal Computer (PC)
- PCs with a Web-Browser (Internet Explorer 4.0 or higher, or Netscape Navigator 4.7 or higher)

Package Content

- One Broadband router unit
- One Quick Installation Guide
- One User Manual CD
- One Power Adapter
- Accessories

Note

The WAN "idle timeout" auto-disconnect function may not work due to abnormal activities of some network application software, computer virus or hacker attacks from the Internet. For example, some software sends network packets to the Internet in the background, even when you are not using the Internet. So please turn off your computer when you are not using it. This function also may not work with some ISP. So please make sure this function can work properly when you use this function in the first time, especially when your ISP charge you by time used.

Get to know the Broadband Router

Back Panel

The diagram (fig1.0) below shows the broadband router's back panel. The router's back panel is divided into three sections, **LAN**, **WAN** and **Reset**:

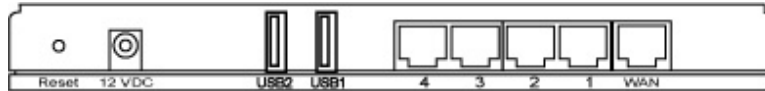

Figure 1.0

1) Local Area Network (LAN)

The Broadband router's 4 LAN ports are where you connect your LAN's PCs, printer servers, hubs and switches etc.

2) Wide Area Network (WAN)

The WAN port is the segment connected to your xDSL or Cable modem and is linked to the Internet.

3) Reset

The Reset button allows you to do one of two things.

- 1) If problems occur with your router, press the router's reset button with a pencil tip (for less than 4 seconds) and the router will re-boot itself, keeping your original configurations.
- 2) If problems persist or you experience extreme problems or you forgot your password, press the reset button for longer than 4 seconds and the router will reset itself to the factory default settings (**warning**: your original configurations will be replaced with the factory default settings)

Front Panel

On the router's front panel there are LED lights that inform you of the router's current status. Below is an explanation of each LED and its description.



| LED | Light Status | Description |
|---------------------------|--------------|--|
| PWR | ON | Router's power supply is on |
| USB1 | Flash | Data is transmitting |
| | OFF | No data transmitted |
| USB2 | Flash | Data is transmitting |
| | OFF | No data transmitted |
| WAN 10/100M | ON | WAN port 100Mbps is connected |
| | Off | WAN port 10Mbps is connected |
| WAN LNK/ACT | ON | WAN is connected |
| | Off | No WAN connection |
| | Flashing | WAN port has Activity (ACT), data being sent |
| LAN 10/100M (Port 1-4) | ON | LAN port 100Mbps is connected |
| | Off | LAN port 10Mbps is connected |
| LAN LNK/ACT (Port 1-4) | ON | LAN is connected |
| | Off | No LAN connection |
| | Flashing | LAN port has Activity (ACT), data being sent |

Setup Diagram

Figure 1.2 below shows a typical setup for a Local Area Network (LAN).

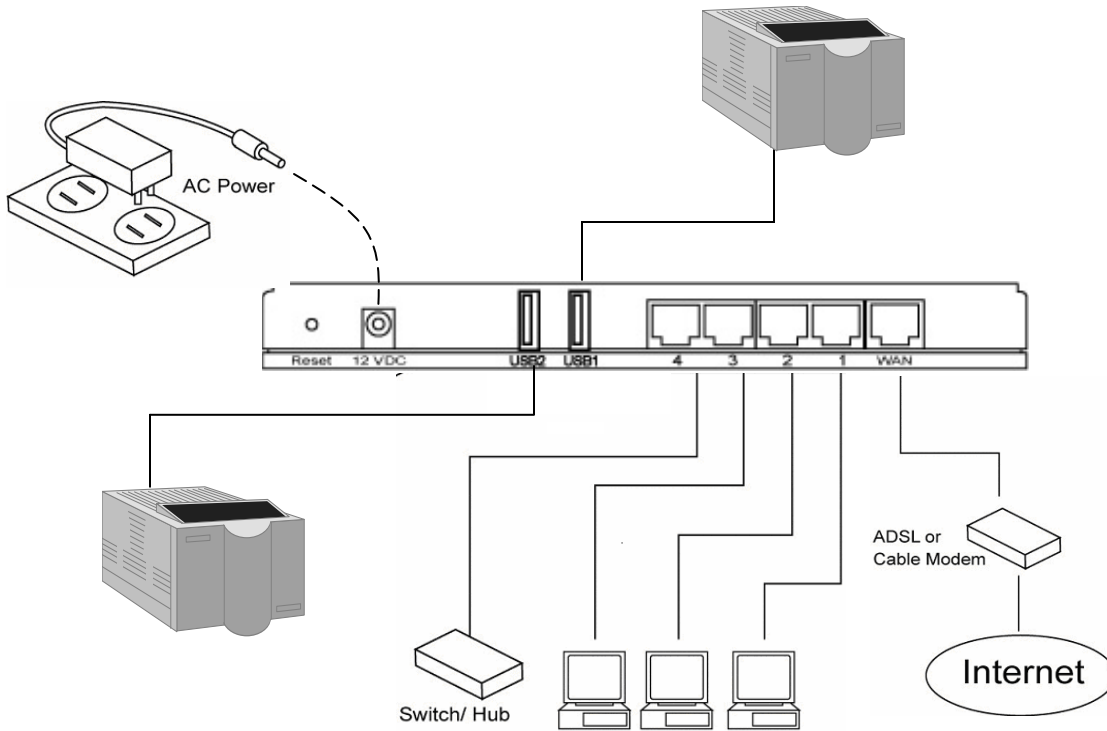

Figure 1.2

Getting started

This is a step-by-step instruction on how to start using the router and get connected to the Internet.

- 1) Setup your network as shown in the setup diagram above (fig 1.2).
- 2) You then need to set your LAN PC clients so that it can obtain an IP address automatically. All LAN clients require an IP address. Just like an address, it allows LAN clients to find one another. (If you have already configured your PC to obtain an IP automatically then proceed to step 3, page 11)

Configure your PC to obtain an IP address automatically

By default the broadband router's DHCP is on, this means that you can obtain an IP address automatically once you've configured your PC to obtain an IP address automatically. This section will show you how to configure your PC's so that it can obtain an IP address automatically for either Windows 95/98/Me, 2000 or NT operating systems. For other operating systems (Macintosh, Sun, etc.), follow the manufacturer's instructions. The following is a step-by-step illustration on how to configure your PC to obtain an IP address automatically for 2a) **Windows 95/98/Me**, 2b) **Windows XP**, 2c) **Windows 2000** and 2d) **Windows NT**.

2a) Windows 95/98/Me

- 1: Click the *Start* button and select *Settings*, then click *Control Panel*. The *Control Panel* window will appear.
- 2: Double-click *Network* icon. The *Network* window will appear.
- 3: Check your list of Network Components. If TCP/IP is not installed, click the *Add* button to install it now. If TCP/IP is installed, go to **step 6**.
- 4: In the *Network Component Type* dialog box, select *Protocol* and click *Add* button.
- 5: In the *Select Network Protocol* dialog box, select *Microsoft* and *TCP/IP* and then click the *OK* button to start installing the TCP/IP protocol. You may need your Windows CD to complete the installation.
- 6: After installing TCP/IP, go back to the *Network* dialog box. Select *TCP/IP* from the list of *Network Components* and then click the *Properties* button.
- 7: Check each of the tabs and verify the following settings:
 - **Bindings:** Check *Client for Microsoft Networks* and *File and printer sharing for Microsoft Networks*.
 - **Gateway:** All fields are blank.
 - **DNS Configuration:** Select *Disable DNS*.
 - **WINS Configuration:** Select *Disable WINS Resolution*.
 - **IP Address:** Select *Obtain IP address automatically*.

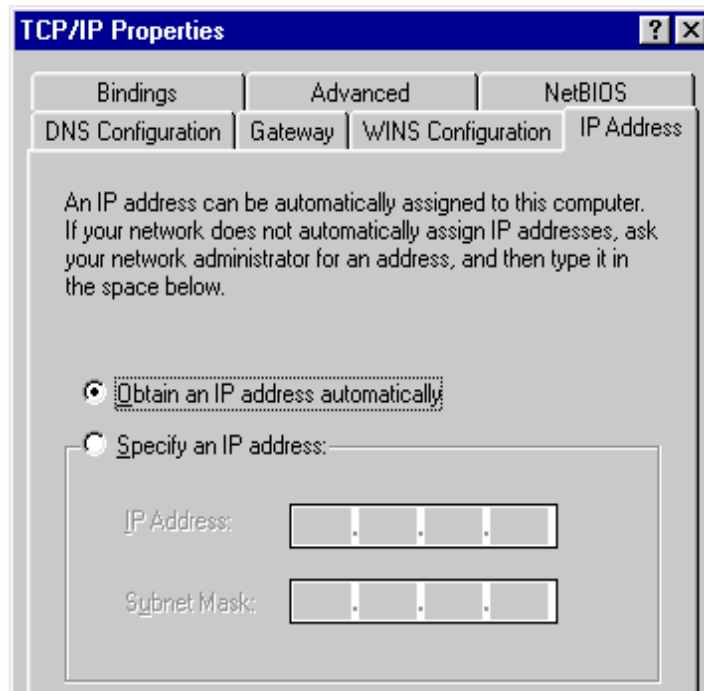

8: Reboot the PC. Your PC will now obtain an IP address automatically from your Broadband Router's DHCP server.

Note: Please make sure that the Broadband router's DHCP server is the only DHCP server available on your LAN.

Once you've configured your PC to obtain an IP address automatically, please proceed to Step 3

2b) Windows XP

- 1: Click the *Start* button and select *Settings*, then click *Network Connections*. The *Network Connections* window will appear.
- 2: Double-click *Local Area Connection* icon. The *Local Area Connection* window will appear.
- 3: Check your list of Network Components. You should see *Internet Protocol [TCP/IP]* on your list. Select it and click the *Properties* button.
- 4: In the Internet Protocol (TCP/IP) Properties window, select *Obtain an IP address automatically* and *Obtain DNS server address automatically* as shown on the following screen.

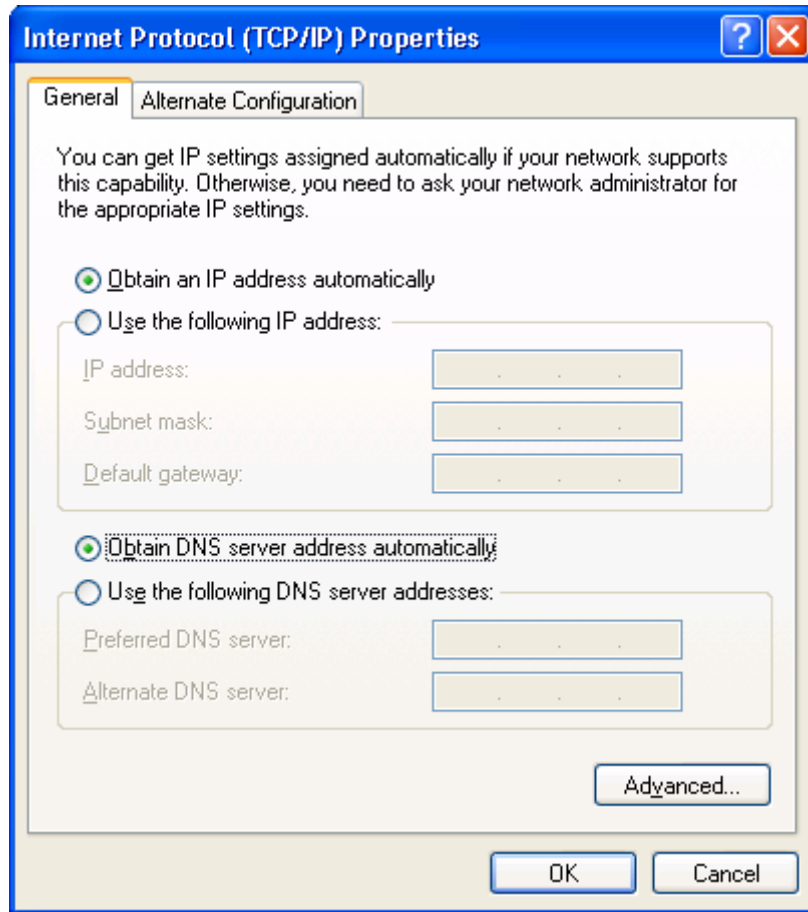

5: Click *OK* to confirm the setting. Your PC will now obtain an IP address automatically from your Broadband Router's DHCP server.

Note: Please make sure that the Broadband router's DHCP server is the only DHCP server available on your LAN.

Once you've configured your PC to obtain an IP address automatically, please proceed to Step 3.

2c) Windows 2000

1: Click the *Start* button and select *Settings*, then click *Control Panel*. The *Control Panel* window will appear.

2: Double-click *Network and Dial-up Connections* icon. In the *Network and Dial-up Connection* window, double-click *Local Area Connection* icon. The *Local Area Connection* window will appear.

3: In the *Local Area Connection* window, click the *Properties* button.

4: Check your list of Network Components. You should see *Internet Protocol [TCP/IP]* on your list. Select it and click the *Properties* button.

5: In the Internet Protocol (TCP/IP) Properties window, select *Obtain an IP address*

automatically and Obtain DNS server address automatically as shown on the following screen.

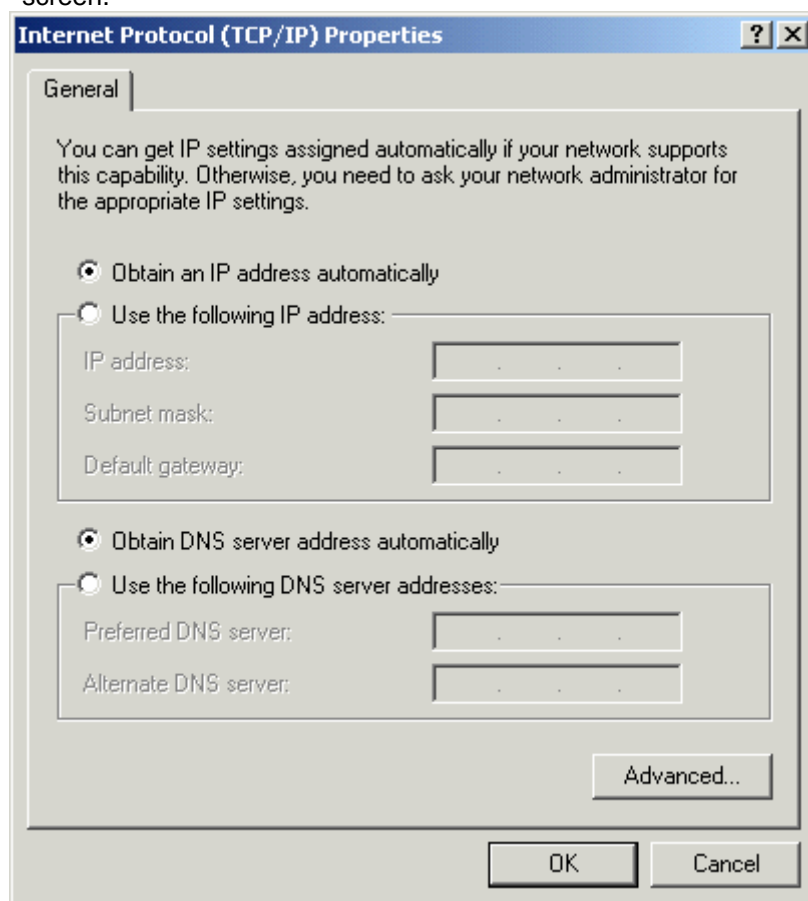

6: Click *OK* to confirm the setting. Your PC will now obtain an IP address automatically from your Broadband Router's DHCP server.

Note: Please make sure that the Broadband router's DHCP server is the only DHCP server available on your LAN.

Once you've configured your PC to obtain an IP address automatically, please proceed to Step 3.

2d) Windows NT

1: Click the *Start* button and select *Settings*, then click *Control Panel*. The *Control Panel* window will appear.

2: Double-click *Network* icon. The *Network* window will appear. Select the *Protocol* tab from the *Network* window.

3: Check if the *TCP/IP Protocol* is on your list of *Network Protocols*. If TCP/IP is not installed, click the *Add* button to install it now. If TCP/IP is installed, go to **step 5**.

4: In the *Select Network Protocol* window, select the *TCP/IP Protocol* and click the *Ok*

button to start installing the TCP/IP protocol. You may need your Windows CD to complete the installation.

5: After you install TCP/IP, go back to the *Network* window. Select *TCP/IP* from the list of *Network Protocols* and then click the *Properties* button.

6: Check each of the tabs and verify the following settings:

- **IP Address:** Select *Obtain an IP address from a DHCP server*.
- **DNS:** Let all fields be blank.
- **WINS:** Let all fields be blank.
- **Routing:** Let all fields be blank.

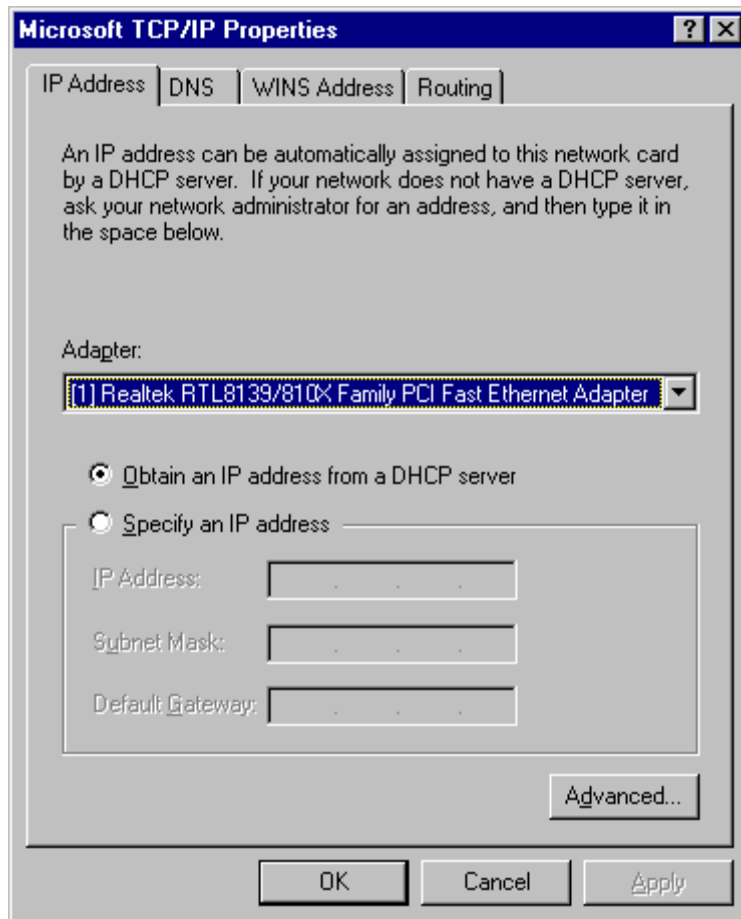

7: Click *OK* to confirm the setting. Your PC will now obtain an IP address automatically from your Broadband Router's DHCP server.

Note: Please make sure that the Broadband router's DHCP server is the only DHCP server available on your LAN.

Once you've configured your PC to obtain an IP address automatically, please proceed to Step 3.

- 3) Once you have configured your PCs to obtain an IP address automatically, the router's DHCP server will automatically give your LAN clients an IP address. By default the Broadband Router's DHCP server is enabled so that you can obtain an IP address automatically. To see if you have obtained an IP address, see Appendix A.

Note: Please make sure that the Broadband router's DHCP server is the only DHCP server available on your LAN. If there is another DHCP on your network, then you'll need to switch one of the DHCP servers off. (To disable the Broadband router's DHCP server see chapter 2 LAN Port)

- 4) Once your PC has obtained an IP address from your router, enter the default IP address **192.168.2.1** (broadband router's IP address) into your PC's web browser and press <enter>



- 5) The login screen below will appear. Enter the "User Name" and "Password" and then click <OK> to login.

Note: By default the user name is "admin" and the password is "1234". For security reasons it is recommended that you change the password as soon as possible (in General setup/system/password, see chapter 2)



- 6) The **HOME** page screen below will appear. The **Home** Page is divided into four sections, **Quick Setup Wizard**, **General Setup**, **Status Information** and **Tools**.

Quick Setup Wizard (*Chapter 1*)

If you only want to start using the broadband router as an Internet Access device then you **ONLY** need to configure the screens in the Quick Setup Wizard section.

General Setup (*Chapter 2*)

If you want to use more advanced features that the broadband router has to offer, then you'll need to configure the Quick Setup Wizard and the General Setup section. Alternatively, you

can just configure the General Setup section, since the General Setup/WAN and the Quick Setup Wizard contain the same configurations.

Status Information (*Chapter 3*)

The Status Information section is for you to monitor the router's current status information only.

Tools (*Chapter 4*)

If you want to Reset the router (because of problems) or save your configurations or upgrade the firmware then the Tools section is the place to do this.

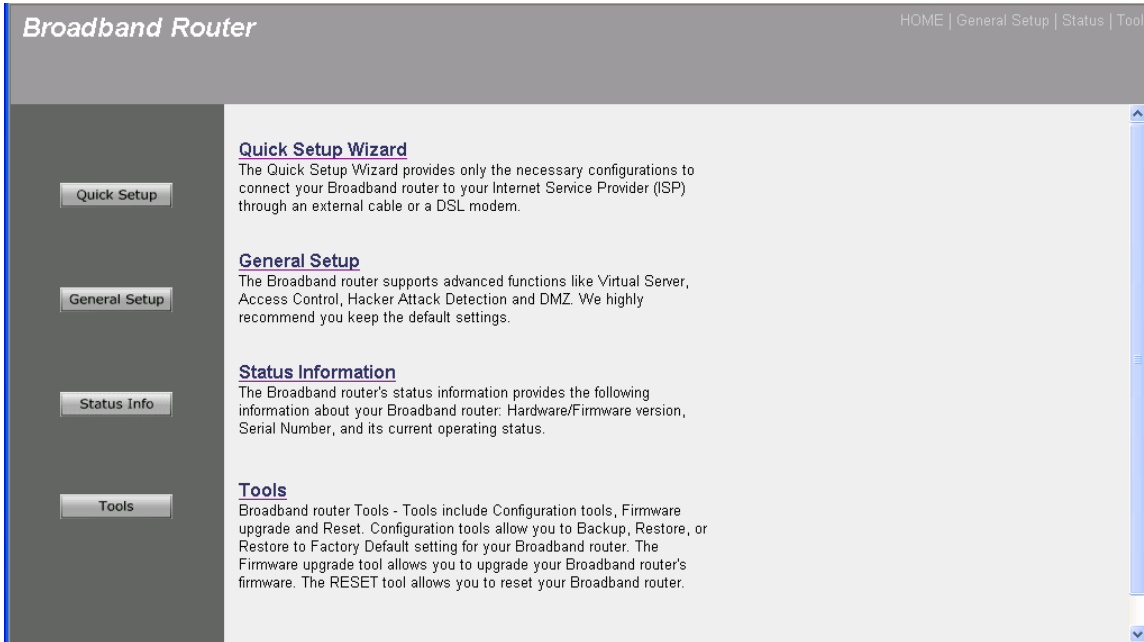

| Menu | Description |
|--|---|
| Quick Setup Wizard (<i>Chapter 1</i>) | Select your Internet connection type and then input the configurations needed to connect to your Internet Service Provider (ISP). |
| General Setup (<i>Chapter 2</i>) | This section contains configurations for the Broadband router's advance functions such as: Address Mapping, Virtual Server, Access Control, Hacker Attack Prevention, DMZ, Special applications and other functions, to meet your LAN requirements. |
| Status Information (<i>Chapter 3</i>) | In this section you can see the Broadband router's system information, Internet Connection, Device Status, Security Log and DHCP client Log information. |

Tools (*Chapter 4*)

This section contains the broadband router's Tools - Tools include Configuration tools, Firmware upgrade and Reset. Configuration tools allow you to Backup (save), Restore, or Restore to Factory Default configuration for your Broadband router. The Firmware upgrade tool allows you to upgrade your Broadband router's firmware. The RESET tool allows you to reset your Broadband router.

- 7) Click on **Quick Setup Wizard** (see chapter 1) to start configuring settings required by your ISP so that you can start accessing the Internet. The other sections (General Setup, Status Information and Tools) do not need to be configured unless you wish to implement/monitor more advance features/information.

Select the section (Quick Setup Wizard, General Setup, Status Information and Tools) you wish to configure and proceed to the corresponding chapter. Use the selections on the web management's top right hand page to navigate around the web-based management User Interface.

Chapter 1

Quick Setup

The Quick Setup section is designed to get you using the broadband router as quick as possible. In the Quick Setup you are required to fill in only the information necessary to access the Internet. Once you click on the **Quick Setup Wizard** in the HOME page, you should see the screen below.

Step 1) Time Zone

The Time Zone allows your router to base its time on the settings configured here, this will affect functions such as Log entries and Firewall settings.

The screenshot shows the 'Time Zone' configuration page of a Broadband Router. The page title is 'Broadband Router' and the breadcrumb trail is 'HOME | General Setup | Status | Tool'. On the left, there is a navigation menu under 'System' with options: Time Zone (selected), Password Settings, Remote Management, WAN, LAN, NAT, Firewall, and Print Server. The main content area is titled 'Time Zone' and includes a help icon. Below the title, it says 'Set the time zone of the Broadband router. This information is used for log entries and firewall settings.' The configuration fields are: 'Set Time Zone' with a dropdown menu showing '(GMT)Greenwich Mean Time: Dublin, Edinburgh, Lisbon, London'; 'Time Server Address' with a text input field containing '192.43.244.18'; and 'Daylight Savings' with an unchecked 'Enable Function' checkbox and two sets of dropdown menus for 'Times From' and 'To', both set to 'January 1'. At the bottom right, there are 'Apply' and 'Cancel' buttons.

| Parameter | Description |
|------------------------------------|--|
| Set Time Zone | Select the time zone of the country you are currently in. The router will set its time based on your selection. |
| Time Server Address | You can manually assign time server address if the default time server dose not work. |
| Enable Daylight Savings | The router can also take Daylight savings into account. If you wish to use this function, you must check/tick the enable box to enable your daylight saving configuration (below). |
| Start Daylight Savings Time | Select the period in which you wish to start daylight Savings Time |
| End Daylight Savings Time | Select the period in which you wish to end daylight Savings Time |

Click on **NEXT** to proceed to the next page (step 2) Broadband Type.

Step 2) Broadband Type

In this section you have to select one of four types of connections that you will be using to connect your broadband router's WAN port to your ISP (see screen below).

Note: Different ISP's require different methods of connecting to the Internet, please check with your ISP as to the type of connection it requires.

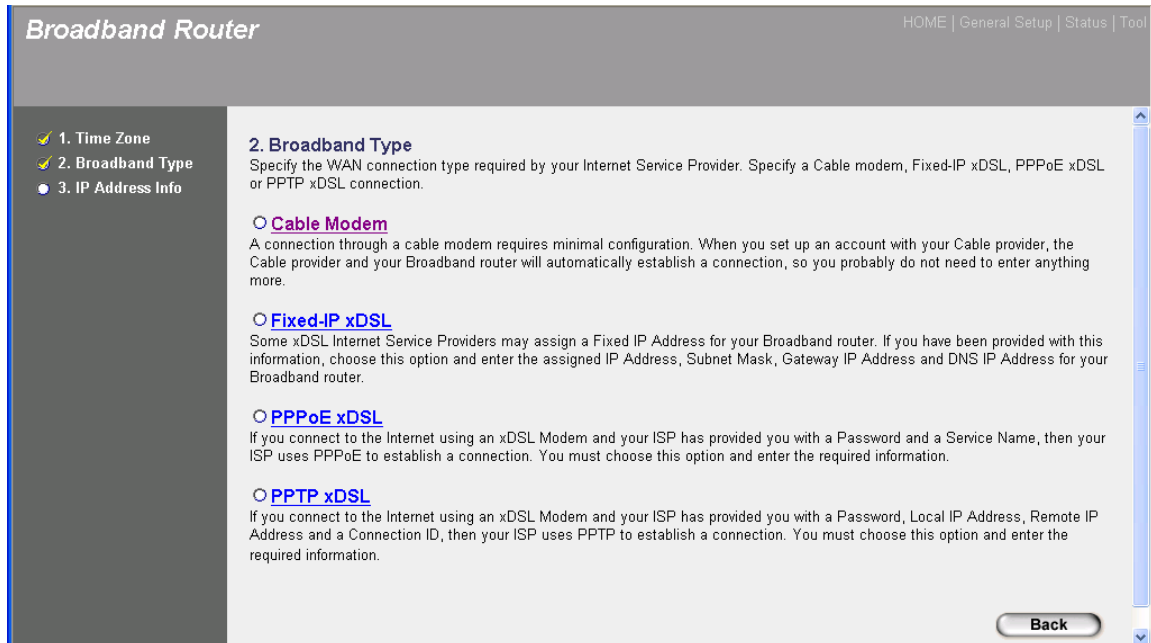

| Menu | Description |
|--------------------------|--|
| 1.1 Cable Modem | Your ISP will automatically give you an IP address |
| 1.2 Fixed-IP xDSL | Your ISP has given you an IP address already |
| 1.3 PPPoE | Your ISP requires you to use a Point-to-Point Protocol over Ethernet (PPPoE) connection. |
| 1.4 PPTP | Your ISP requires you to use a Point-to-Point Tunneling Protocol (PPTP) connection. |

Click on one of the WAN type and then proceed to the manual's relevant sub-section (**1.1**, **1.2**, **1.3** or **1.4**). Click on **Back** to return to the previous screen.

1.1 Cable Modem

Choose Cable Modem if your ISP will automatically give you an IP address. Some ISP's may also require that you fill in additional information such as Host Name and MAC address (see screen below).

Note: The Host Name and MAC address section is *optional* and you can skip this section if your ISP does not require these settings for you to connect to the Internet.

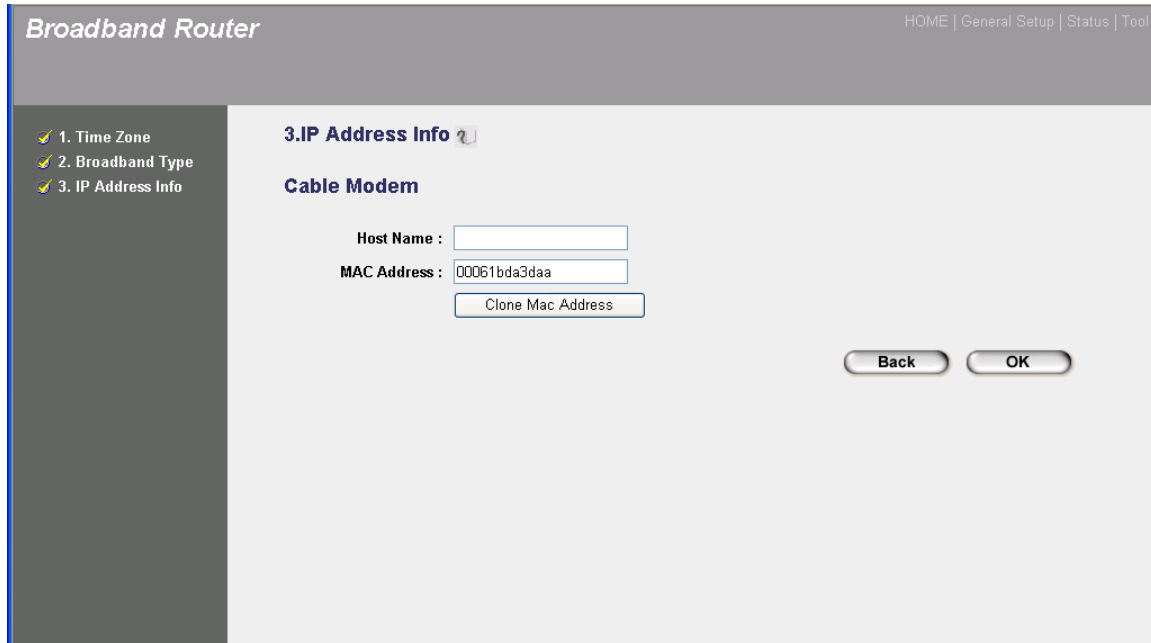

The screenshot shows the 'Broadband Router' configuration interface. At the top, there are navigation links: 'HOME | General Setup | Status | Tool'. On the left, a sidebar lists three steps: '1. Time Zone', '2. Broadband Type', and '3. IP Address Info', with the third step being the active one. The main content area is titled '3.IP Address Info' and contains a sub-section 'Cable Modem'. Under this section, there are two input fields: 'Host Name' (empty) and 'MAC Address' (containing '00061bda3daa'). Below the MAC Address field is a button labeled 'Clone Mac Address'. At the bottom right of the form are two buttons: 'Back' and 'OK'.

| Parameters | Description |
|-------------|---|
| Host Name | If your ISP requires a Host Name, type in the host name provided by your ISP, otherwise leave it blank if your ISP does not require a Host Name. |
| MAC Address | Your ISP may require a particular MAC address in order for you to connect to the Internet. This MAC address is the PC's MAC address that your ISP had originally connected your Internet connection to. Type in this MAC address in this section or use the " Clone MAC Address " button to replace the WAN MAC address with the MAC address of that PC (you have to be using that PC for the Clone MAC Address button to work). To find out the PC's MAC address see Appendix A. (see Glossary for an explanation on MAC address) |

Click <OK> when you have finished the configuration above. **Congratulations!** You have completed the configuration for the Cable Modem connection. You can start using the router now, if you wish to use some of the advance features supported by this router see chapter 2, 3, 4.

1.2 Fixed-IP xDSL

Select Fixed-IP xDSL if your ISP has given you a specific IP address for you to use. Your ISP should provide all the information required in this section.

| Parameters | Description |
|-------------|---|
| IP | This is the IP address that your ISP has given you. |
| Gateway IP | This is the ISP's IP address gateway |
| DNS | This is the ISP's DNS server IP address |
| Subnet Mask | Enter the Subnet Mask provided by your ISP (e.g. 255.255.255.0) |

Click <OK> when you have finished the configuration above. **Congratulations!** You have completed the configuration for the Fixed-IP x DSL connection. You can start using the router now, if you wish to use some of the advance features supported by this router see chapter 2, 3, 4.

1.3 PPPoE

Select PPPoE if your ISP requires the PPPoE protocol to connect you to the Internet. Your ISP should provide all the information required in this section.

Broadband Router HOME | General Setup | Status | Tool

- ✔ 1. Time Zone
- ✔ 2. Broadband Type
- ✔ 3. IP Address Info

3.IP Address Info ?

PPPoE
Enter the User Name and Password required by your ISP in the appropriate fields. If your ISP has provided you with a "Service Name" enter it in the Service Name field, otherwise, leave it blank.

Use PPPoE Authentication

| | |
|--------------------------|---|
| User Name : | <input style="width: 90%;" type="text"/> |
| Password : | <input style="width: 90%;" type="password"/> |
| Service Name : | <input style="width: 90%;" type="text"/> |
| MTU : | <input style="width: 60%;" type="text" value="1392"/> (512<=MTU Value<=1492) |
| Connection Type : | <input type="text" value="Continuous"/> Connect Disconnect |
| Idle Time : | <input style="width: 60%;" type="text" value="10"/> (1-1000 minutes) |

Back
OK

| Parameter | Description |
|-----------------|--|
| User Name | Enter the User Name provided by your ISP for the PPPoE connection |
| Password | Enter the Password provided by your ISP for the PPPoE connection |
| Service Name | This is optional. Enter the Service name should your ISP requires it, otherwise leave it blank. |
| MTU | This is optional. You can specify the maximum size of your transmission packet to the Internet. Leave it as it is if you to not wish to set a maximum packet size. |
| Connection Type | <p>If you select “Continuous”, the router will always connect to the ISP. If the WAN line breaks down and links again, the router will auto-reconnect to the ISP.</p> <p>If you select “Connect On Demand”, the router will auto-connect to the ISP when someone want to use the Internet and keep connected until the WAN idle timeout. The router will close the WAN connection if the time period that no one is using the Internet exceeds the “Idle Time”.</p> <p>If you select “Manual”, the router will connect to ISP only when you click “Connect” manually from the Web user interface. The WAN connection will not disconnected due to the idle timeout. If the WAN line breaks down and latter links again, the router will not auto-connect to the ISP.</p> |

Idle Time

You can specify an idle time threshold (minutes) for the WAN port. This means if no packets have been sent (no one using the Internet) during this specified period, the router will automatically disconnect the connection with your ISP.

Note: This “idle timeout” function may not work due to abnormal activities of some network application software, computer virus or hacker attacks from the Internet. For example, some software sends network packets to the Internet in the background, even when you are not using the Internet. So please turn off your computer when you are not using it. This function also may not work with some ISP. So please make sure this function can work properly when you use this function in the first time, especially your ISP charge you by time used.

Click **<OK>** when you have finished the configuration above. **Congratulations!** You have completed the configuration for the PPPoE connection. You can start using the router now, if you wish to use some of the advance features supported by this router see chapter 2, 3, 4.

1.4 PPTP

Select PPTP if your ISP requires the PPTP protocol to connect you to the Internet. Your ISP should provide all the information required in this section.

The screenshot shows the 'Broadband Router' configuration interface. The breadcrumb trail is 'HOME | General Setup | Status | Tool'. The left sidebar shows a progress indicator for three steps: '1. Time Zone', '2. Broadband Type', and '3. IP Address Info'. The main content area is titled '3. IP Address Info' and contains a sub-section for 'PPTP'. A descriptive text states: 'Point-to-Point Tunneling Protocol is a common connection method used in xDSL connections.' Below this, there are two main sections: 'WAN Interface Settings' and 'PPTP Settings'. Under 'WAN Interface Settings', there are two radio button options: 'Obtain an IP address automatically' (which is selected) and 'Use the following IP address'. The 'Obtain an IP address automatically' option includes fields for 'Host Name', 'MAC Address' (with a 'Clone Mac' button), and 'Use the following IP address' which includes fields for 'IP Address', 'Subnet Mask', and 'Default Gateway'. The 'PPTP Settings' section includes fields for 'User ID', 'Password', and 'PPTP Gateway'.

| Parameter | Description |
|------------------------------------|--|
| Obtain an IP address automatically | The ISP requires you to obtain an IP address by DHCP before connecting to the PPTP server. |

| | |
|------------------------------|--|
| Use the following IP address | The ISP gives you a static IP to be used to connect to the PPTP server. |
| IP Address | This is the IP address that your ISP has given you to establish a PPTP connection. |
| Subnet Mask | Enter the Subnet Mask provided by your ISP (e.g. 255.255.255.0) |
| Gateway | Enter the IP address of the ISP Gateway |
| User ID | Enter the User Name provided by your ISP for the PPTP connection. Sometimes called a Connection ID |
| Password | Enter the Password provided by your ISP for the PPTP connection |
| PPTP Gateway | If your LAN has a PPTP gateway, then enter that PPTP gateway IP address here. If you do not have a PPTP gateway then enter the ISP's Gateway IP address above |
| Connection ID | This is the ID given by ISP. This is optional. |
| BEZEQ-ISRAEL | Select this item if you are using the service provided by BEZEQ in Israel. |
| Connection Type | <p>If you select "Continuous", the router will always connect to the ISP. If the WAN line breaks down and links again, the router will auto-reconnect to the ISP.</p> <p>If you select "Connect On Demand", the router will auto-connect to the ISP when someone want to use the Internet and keep connected until the WAN idle timeout. The router will close the WAN connection if the time period that no one is using the Internet exceeds the "Idle Time".</p> <p>If you select "Manual", the router will connect to ISP only when you click "Connect" manually from the Web user interface. The WAN connection will not disconnected due to the idle timeout. If the WAN line breaks down and latter links again, the router will not auto-connect to the ISP.</p> |
| Idle Time | <p>You can specify an idle time threshold (minutes) for the WAN port. This means if no packets have been sent (no one using the Internet) throughout this specified period, then the router will automatically disconnect the connection with your ISP.</p> <p>Note: This "idle timeout" function may not work due to abnormal activities of some network application software, computer virus or hacker attacks from the Internet. For example, some software sends network packets to the Internet in the background, even when you are not using the Internet. So please turn off your</p> |

computer when you are not using it. This function also may not work with some ISP. So please make sure this function can work properly when you use this function in the first time, especially your ISP charge you by time used.

Click **<OK>** when you have finished the configuration above. **Congratulations!** You have completed the configuration for the PPTP connection. You can start using the router now, if you wish to use some of the advance features supported by this router see chapter 2, 3, 4.

Chapter 2

General Settings

Once you click on the **General Setup** button at the Home Page, you should see the screen below.

If you have already configured the Quick Setup Wizard you do NOT need to configure anything thing in the General Setup screen for you to start using the Internet.

The General Setup contain advanced features that allow you to configure the router to meet your network's needs such as: Address Mapping, Virtual Server, Access Control, Hacker Attack Prevention, Special Applications, DMZ and other functions.

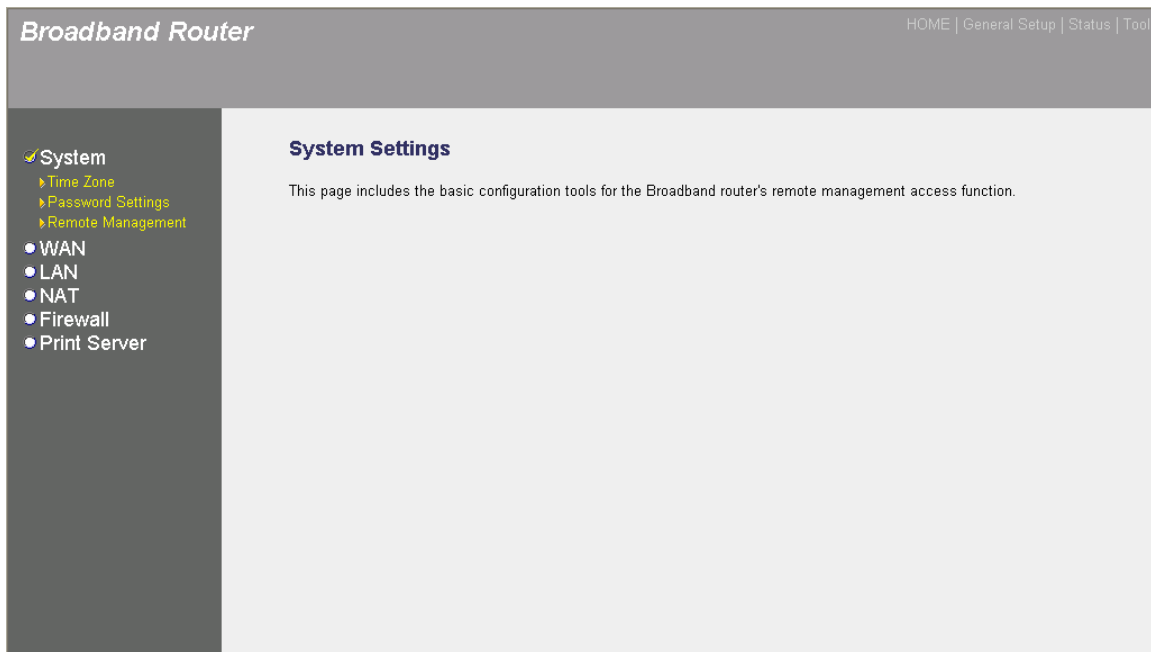

Below is a general description of what advance functions are available for this broadband router.

| Menu | Description |
|------|-------------|
|------|-------------|

| | |
|------------------|---|
| 2.1 System | This section allows you to set the Broadband router's system Time Zone, Password and Remote Management Administrator. |
| 2.2 WAN | This section allows you to select the connection method in order to establish a connection with your ISP (same as the Quick Setup Wizard section) |
| 2.3 LAN | You can specify the LAN segment's IP address, subnet Mask, enable/disable DHCP and select an IP range for your LAN |
| 2.4 NAT | You can configure the Address Mapping, Virtual Server and Special Applications functions in this section. This allows you to specify what user/packet can pass your router's NAT. |
| 2.5 Firewall | The Firewall section allows you to configure Access Control, Hacker Prevention and DMZ. |
| 2.6 Print Server | The Print Server allows you to configure the print server function. |

Select one of the above five General Setup selections and proceed to the manual's relevant sub-section

2.1 System

The system screen allows you to specify a time zone, to change the system password and to specify a remote management user for the broadband router.

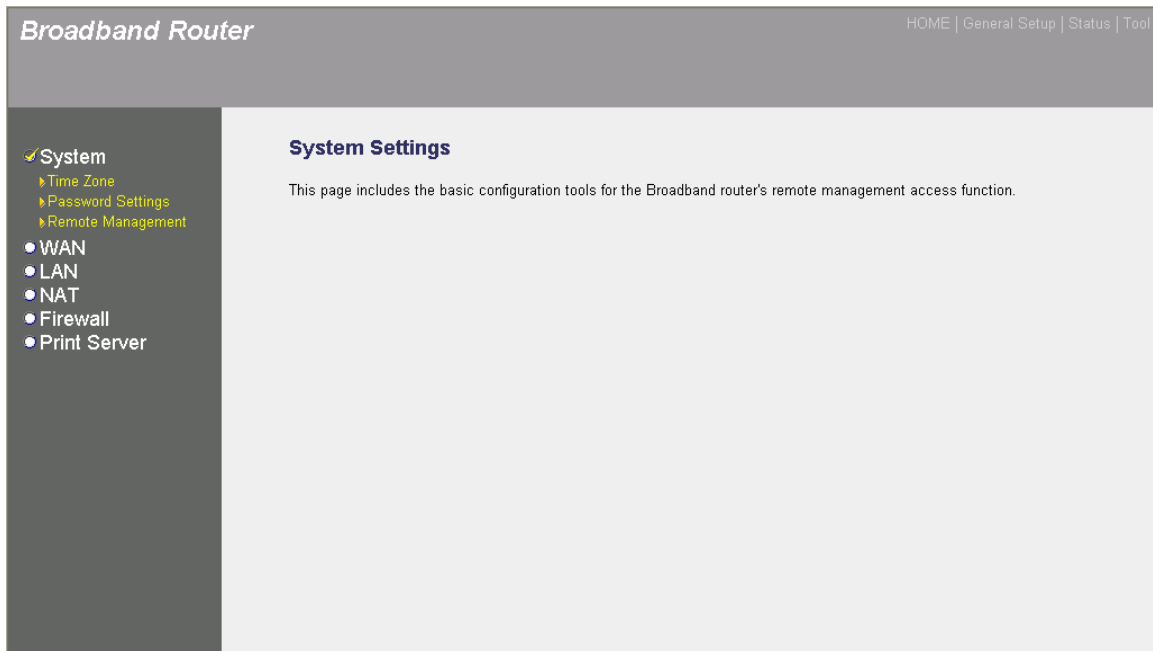

| Parameters | Description |
|-------------------------|---|
| <i>System Settings</i> | |
| 2.1.1 Time Zone | Select the time zone of the country you are currently in. The router will set its time based on your selection. |
| 2.1.2 Password Settings | Allows you to select a password in order to access the web-based management website. |
| 2.1.3 Remote Management | You can specify a Host IP address that can perform remote management functions. |

Select one of the above three system settings selections and proceed to the manual's relevant sub-section

2.1.1 Time Zone

The Time Zone allows your router to reference or base its time on the settings configured here, which will affect functions such as Log entries and Firewall settings.

| Parameter | Description |
|----------------------------|---|
| Set Time Zone | Select the time zone of the country you are currently in. The router will set its time based on your selection. |
| Time Server Address | You can manually assign time server address if the default time server dose not work. |

Enable Daylight Savings

The router can also take Daylight savings into account. If you wish to use this function, you must check/tick the enable box to enable your daylight saving configuration (below).

Start Daylight Savings Time

Select the period in which you wish to start daylight Savings Time

End Daylight Savings Time

Select the period in which you wish to end daylight Savings Time

Click **<Apply>** at the bottom of the screen to save the above configurations. You can now configure other advance sections or start using the router (with the advance settings in place)

2.1.2 Password Settings

You can change the password required to log into the broadband router's system web-based management. By default, there is no password. So please assign a password to the Administrator as soon as possible, and store it in a safe place. Passwords can contain 0 to 30 alphanumeric characters, and are case sensitive.

Broadband Router HOME | General Setup | Status | Tool

System

- Time Zone
- Password Settings
- Remote Management

• WAN

• LAN

• NAT

• Firewall

• Print Server

Password Setup

You can change the password required to log into the broadband router's system web-based management. By default, the password is 1234. So please assign a password to the Administrator as soon as possible, and store it in a safe place. Passwords can contain 0 to 30 alphanumeric characters, and are case sensitive.

Current Password :

New Password :

Confirmed Password :

Parameters

Description

Current Password

Enter your current password for the remote management administrator to login to your Broadband router.
Note: By default there is NO password

New Password

Enter your new password

Confirmed Password

Enter your new password again for verification purposes

Note: If you forget your password, you'll have to reset the router to the factory default (No password) with the reset button (see router's back panel)

Click **<Apply>** at the bottom of the screen to save the above configurations. You can now configure other advance sections or start using the router (with the advance settings in place)

2.1.3 Remote Management

The remote management function allows you to designate a host in the Internet the ability to configure the Broadband router from a remote site. Enter the designated host IP Address in the Host IP Address field.

The screenshot shows the 'Broadband Router' web interface. The top navigation bar includes 'HOME | General Setup | Status | Tool'. A left sidebar menu lists 'System' (with sub-items 'Time Zone', 'Password Settings', and 'Remote Management') and other sections: 'WAN', 'LAN', 'NAT', 'Firewall', and 'Print Server'. The main content area is titled 'Remote Management' and contains a descriptive paragraph: 'The remote management function allows you to designate a host in the Internet to have management/configuration access to the Broadband router from a remote site. Enter the designated host IP Address in the Host IP Address field.' Below this text is a table with three columns: 'Host Address', 'Port', and 'Enabled'. The 'Host Address' field contains '0.0.0.0', the 'Port' field contains '8080', and the 'Enabled' column has an unchecked checkbox. At the bottom right of the table are 'Apply' and 'Cancel' buttons.

| Parameters | Description |
|------------|-------------|
|------------|-------------|

Host Address

This is the IP address of the host in the Internet that will have management/configuration access to the Broadband router from a remote site. This means if you are at home and your home IP address has been designated the Remote Management host IP address for this router (located in your company office), then you are able to configure this router from your home. If the Host Address is left **0.0.0.0** this means anyone can access the router's web-based configuration from a remote location, providing they know the password.

Click the **Enabled** box to enable the Remote Management function.

Note: When you want to access the web-based management from a remote site, you must enter the router's WAN IP address (e.g. 10.0.0.1) into your web-browser followed by port number 8080, e.g. 10.0.0.1:8080 (see below). You'll also need to know the password set in the Password Setting screen in order to access the router's web-based management.

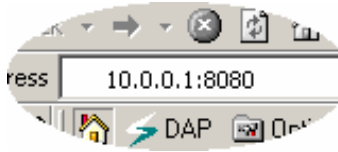

Port The port number of remote management web interface.

Enabled Select "Enabled" to enable the remote management function.

Click **<Apply>** at the bottom of the screen to save the above configurations. You can now configure other advance sections or start using the router (with the advance settings in place)

2.2 WAN

Use the WAN Settings screen if you have already configured the Quick Setup Wizard section and you would like to change your Internet connection type. The WAN Settings screen allows you to specify the type of WAN port connect you want to establish with your ISP. In the WAN Settings screen you can also specify the router to act as a Bridge. The WAN settings offer the following selections for the router's WAN port, **Dynamic IP**, **PPPoE**, **PPTP**, **Static IP Address**, **L2TP**, **Telstra Big Pond**, **DNS** and **DDNS**.

 A screenshot of the 'Broadband Router' web interface. The page title is 'Broadband Router' and there are navigation links for 'HOME | General Setup | Status | Tool'. A left sidebar contains a menu with 'System' selected and 'WAN' expanded, showing sub-items: 'Dynamic IP', 'Static IP', 'PPPoE', 'PPTP', 'L2TP', 'Telstra Big Pond', 'DNS', and 'DDNS'. Other menu items include 'LAN', 'NAT', 'Firewall', and 'Print Server'. The main content area is titled 'WAN Settings' and contains the text: 'The Broadband router can be connected to your Service Provider through the following methods:'. Below this is a list of connection methods with radio buttons:

- Dynamic IP**: Obtains an IP Address automatically from your Service Provider.
- Static IP Address**: Uses a Static IP Address. Your Service Provider gives a Static IP Address to access Internet services.
- PPPoE**: PPP over Ethernet is a common connection method used in xDSL connections.
- PPTP**: Point-to-Point Tunneling Protocol is a common connection method used in xDSL connections.
- L2TP**: Layer Two Tunneling Protocol is a common connection method used in xDSL connections.
- Telstra Big Pond**: Telstra Big Pond is a Internet service is provided in Australia.

 At the bottom of the list is a button labeled 'More Configuration'.

| Parameters | Description |
|--------------------------------|--|
| 2.2.1 Dynamic IP | Your ISP will automatically give you an IP address |
| 2.2.2 Static IP address | Your ISP has given you an IP address already |
| 2.2.3 PPPoE | Your ISP requires PPPoE connection. |
| 2.2.4 PPTP | Your ISP requires you to use a Point-to-Point Tunneling Protocol (PPTP) connection. |
| 2.2.5 L2TP | Your ISP requires L2TP connection. |
| 2.2.6 Telstra Big Pond | Your ISP requires Telstra Big Pond connection. |
| 2.2.7 DNS | You can specify a DNS server that you wish to use |
| 2.2.8 DDNS | You can specify a DDNS server that you wish to use and configure the user name and password provided by you DDNS service provider. |

Once you have made a selection, click **<More Configuration>** at the bottom of the screen and proceed to the manual's relevant sub-section

2.2.1 Dynamic IP

Choose the Dynamic IP selection if your ISP will automatically give you an IP address. Some ISP's may also require that you fill in additional information such as Host Name, Domain Name and MAC address (see chapter 1 "Cable Modem" for more detail)

2.2.2 Static IP Address

Select Static IP address if your ISP has given you a specific IP address for you to use. Your ISP should provide all the information required in this section. (See chapter 1 "Fixed IP" for more detail)

2.2.3 PPPoE (PPP over Ethernet)

Select PPPoE if your ISP requires the PPPoE protocol to connect you to the Internet. Your ISP should provide all the information required in this section. (See chapter 1 "PPPoE" for more detail)

2.2.4 PPTP

Select PPTP if your ISP requires the PPTP protocol to connect you to the Internet. Your ISP should provide all the information required in this section. (See chapter 1 "PPTP" for more detail)

2.2.5 L2TP

Select L2TP if your ISP requires the L2TP protocol to connect you to the Internet. Your ISP should provide all the information required in this section.

The screenshot shows the 'Broadband Router' configuration interface. The left sidebar contains a navigation menu with 'System' selected, and 'WAN' expanded to show 'L2TP' as the active option. The main content area is titled 'L2TP' and includes a brief description: 'Layer Two Tunneling Protocol is a common connection method used in xDSL connections.' Below this, there are two main sections: 'WAN Interface Settings' and 'L2TP Settings'. In 'WAN Interface Settings', the 'Obtain an IP address automatically' radio button is selected. The 'Host Name' field is empty, and the 'MAC Address' field contains '000000000000' with a 'Clone Mac' button next to it. The 'Use the following IP address' radio button is unselected. The 'IP Address', 'Subnet Mask', and 'Default Gateway' fields all contain '0.0.0.0'. In the 'L2TP Settings' section, the 'User ID', 'Password', and 'L2TP Gateway' fields are empty. The 'MTU' field is set to '1392' with a note '(512<=MTU(=Value<=1492))'.

| Parameter | Description |
|------------------------------------|--|
| Obtain an IP address automatically | The ISP requires you to obtain an IP address by DHCP before connecting to the L2TP server. |
| Use the following IP address | The ISP give you a static IP to be used to connect to the L2TP server. |
| IP Address | This is the IP address that your ISP has given you to establish a L2TP connection. |
| Subnet Mask | Enter the Subnet Mask provided by your ISP (e.g. 255.255.255.0) |
| Gateway | Enter the IP address of the ISP Gateway. |
| User ID | Enter the User Name provided by your ISP for the PPTP connection. Sometimes called a Connection ID |
| Password | Enter the Password provided by your ISP for the PPTP connection |

| | |
|-----------------|--|
| L2TP Gateway | If your LAN has a L2TP gateway, then enter that L2TP gateway IP address here. If you do not have a L2TP gateway then enter the ISP's Gateway IP address above |
| Connection Type | <p>If you select "Continuous", the router will always connect to the ISP. If the WAN line breaks down and links again, the router will auto-reconnect to the ISP.</p> <p>If you select "Connect On Demand", the router will auto-connect to the ISP when someone want to use the Internet and keep connected until the WAN idle timeout. The router will close the WAN connection if the time period that no one is using the Internet exceeds the "Idle Time".</p> <p>If you select "Manual", the router will connect to ISP only when you click "Connect" manually from the Web user interface. The WAN connection will not disconnected due to the idle timeout. If the WAN line breaks down and latter links again, the router will not auto-connect to the ISP.</p> |
| Idle Time Out | <p>You can specify an idle time threshold (minutes) for the WAN port. This means if no packets have been sent (no one using the Internet) throughout this specified period, then the router will automatically disconnect the connection with your ISP.</p> <p>Note: This "idle timeout" function may not work due to abnormal activities of some network application software, computer virus or hacker attacks from the Internet. For example, some software sends network packets to the Internet in the background, even when you are not using the Internet. So please turn off your computer when you are not using it. This function also may not work with some ISP. So please make sure this function can work properly when you use this function in the first time, especially your ISP charge you by time used.</p> |

Click <OK> when you have finished the configuration above. **Congratulations!** You have completed the configuration for the L2TP connection. You can start using the router now, if you wish to use some of the advance features supported by this router see chapter 2, 3, 4.

2.2.6 Telstra Big Pond

Select Telstra Big Pond if your ISP requires the Telstra Big Pond protocol to connect you to the Internet. Your ISP should provide all the information required in this section. Telstra Big Pond protocol is used by the ISP in Australia.

Broadband Router HOME | General Setup | Status | Tools

- System
- **WAN**
 - ▶ Dynamic IP
 - ▶ Static IP
 - ▶ PPPoE
 - ▶ PPTP
 - ▶ L2TP
 - ▶ Telstra Big Pond
 - ▶ DNS
 - ▶ DDNS
- LAN
- NAT
- Firewall
- Print Server

Telstra Big Pond (Australia Only) ?

If your Internet service is provided by Telstra Big Pond in Australia, you will need to enter your information below. This information is provided by Teistra BigPond.

User Name :

Password :

User decide login server manually

Login Server :

| Parameter | Description |
|-----------------------------------|--|
| User Name | Enter the User Name provided by your ISP for the Telstra Big Pond connection |
| Password | Enter the Password provided by your ISP for the Telstra Big Pond connection |
| User decide login server manually | Select if you want to assign the IP of Telstra Big Pond's login server manually. |
| Login Server | The IP of the Login Server. |

Click **<OK>** when you have finished the configuration above. **Congratulations!** You have completed the configuration for the Telstra Big Pond connection. You can start using the router now, if you wish to use some of the advance features supported by this router see chapter 2, 3, 4.

[2.2.7 DNS](#)

A Domain Name System (DNS) server is like an index of IP addresses and Web addresses. If you type a Web address into your browser, such as www.router.com, a DNS server will find that name in its index and the matching IP address. Most ISPs provide a DNS server for speed and convenience. If your Service Provider connects you to the Internet with dynamic IP settings, it is likely that the DNS server IP address is provided automatically. However, if there is a DNS server that you would rather use, you need to specify the IP address of that DNS server here.

Broadband Router HOME | General Setup | Status | Tools

- System
- **WAN**
 - ▶ Dynamic IP
 - ▶ Static IP
 - ▶ PPPoE
 - ▶ PPTP
 - ▶ L2TP
 - ▶ Telstra Big Pond
 - ▶ DNS
 - ▶ **DDNS**
- LAN
- NAT
- Firewall
- Print Server

DNS ?

A Domain Name System (DNS) server is like an index of IP Addresses and Web Addresses. If you type a Web address into your browser, such as www.broadbandrouter.com, a DNS server will find that name in its index and find the matching IP address. Most ISPs provide a DNS server for speed and convenience. Since your Service Provider may connect you to the Internet through dynamic IP settings, it is likely that the DNS server IP Address is also provided dynamically. However, if there is a DNS server that you would rather use, you need to specify the IP Address of that DNS server. The primary DNS will be used for domain name access first, in case the primary DNS access failures, the secondary DNS will be used. Has your Internet service provider given you a DNS address?

Domain Name Server (DNS) Address :

Secondary DNS Address (optional) :

| Parameters | Description |
|----------------------------------|--|
| Domain Name Server (DNS) Server | This is the ISP's DNS server IP address that they gave you; or you can specify your own preferred DNS server IP address |
| Secondary DNS Address (optional) | This is optional. You can enter another DNS server's IP address as a backup. The secondary DNS will be used should the above DNS fail. |

Click **<Apply>** at the bottom of the screen to save the above configurations. You can now configure other advance sections or start using the router (with the advance settings in place)

[2.2.8 DDNS](#)

DDNS allows you to map the static domain name to a dynamic IP address. You must get an account, password and your static domain name from the DDNS service providers. This router supports DynDNS and TZO.

Broadband Router HOME | General Setup | Status | Tool

- System
- WAN
 - ▶ Dynamic IP
 - ▶ Static IP
 - ▶ PPPoE
 - ▶ PPTP
 - ▶ L2TP
 - ▶ Telstra Big Pond
 - ▶ DNS
 - ▶ DDNS
- LAN
- NAT
- Firewall
- Print Server

DDNS ?

DDNS allows users to map the static domain name to a dynamic IP address. You must get a account, password and your static domain name from the DDNS service providers. Our products have DDNS support for www.dyndns.org and www.tzo.com now.

Dynamic DNS : Enable Disable

Provider : DynDNS

Domain Name :

Account / E-Mail :

Password / Key :

| Parameters | Default | Description |
|----------------|---------|---|
| Enable/Disable | Disable | Enable/Disable the DDNS function of this router |
| Provider | | Select a DDNS service provider |
| Domain name | | Your static domain name that use DDNS |
| Account/E-mail | | The account that your DDNS service provider assigned to you |
| Password/Key | | The password you set for the DDNS service account above |

Click **<Apply>** at the bottom of the screen to save the above configurations. You can now configure other advance sections or start using the router (with the advance settings in place)

2.3 LAN

The LAN Port screen below allows you to specify a private IP address for your router's LAN ports as well as a subnet mask for your LAN segment.

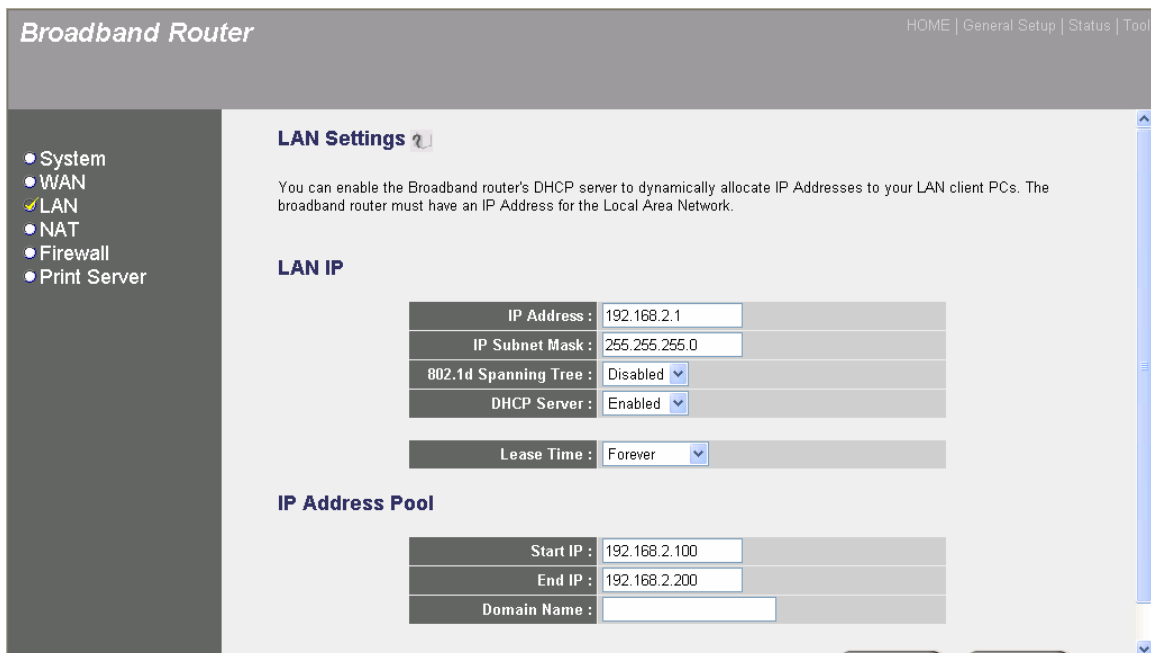

| Parameters | Default | Description |
|----------------------|---------------|--|
| LAN IP | | |
| IP address | 192.168.2.1 | This is the router's LAN port IP address (Your LAN clients default gateway IP address) |
| IP Subnet Mask | 255.255.255.0 | Specify a Subnet Mask for your LAN segment |
| 802.1d Spanning Tree | Disabled | If 802.1d Spanning Tree function is enabled, this router will use the spanning tree protocol to prevent from network loop happened in the LAN ports. |
| DHCP Server | Enabled | You can enable or disable the DHCP server. By enabling the DHCP server the router will automatically give your LAN clients an IP address. If the DHCP is not enabled then you'll have to manually set your LAN client's IP addresses; make sure the LAN Client is in the same subnet as this broadband router if you want the router to be your LAN client's default gateway |
| Lease Time | | The DHCP when enabled will temporarily give your LAN clients an IP address. In the Lease Time setting you can specify the time period that the DHCP lends an IP address to your LAN clients. The DHCP will change your LAN client's IP address when this time threshold period is reached |

IP Address Pool

You can select a particular IP address range for your DHCP server to issue IP addresses to your LAN Clients.

Note: By default the IP range is from: Start IP **192.168.2.100** to End IP **192.168.2.199**. If you want your PC to have a static/fixed IP address then you'll have to choose an IP address outside this IP address Pool

Domain Name

You can specify a Domain Name for your LAN

Click **<Apply>** at the bottom of the screen to save the above configurations. You can now configure other advance sections or start using the router (with the advance settings in place)

2.4 NAT

Network Address Translation (NAT) allows multiple users at your local site to access the Internet through a single Public IP Address or multiple Public IP Addresses. NAT provides Firewall protection from hacker attacks and has the flexibility to allow you to map Private IP Addresses to Public IP Addresses for key services such as Websites and FTP.

 Enable Disable'. At the bottom right of the main content area is an 'Apply' button."/>

Broadband Router HOME | General Setup | Status | Tool

- System
- WAN
- LAN
- ✓ NAT
 - ▶ Port Forwarding
 - ▶ Virtual Server
 - ▶ Special Applications
 - ▶ ALG Settings
- Firewall
- Print Server

NAT Settings

Network Address Translation (NAT) allows multiple users at your local site to access the Internet through a single Public IP Address or multiple Public IP Addresses. NAT provides Firewall protection from hacker attacks and has the flexibility to allow you to map Private IP Addresses to Public IP Addresses for key services such as the Web or FTP.

Enable or disable NAT module function : Enable Disable

Apply

Parameter

Description

2.4.1 Port Forwarding

You can have different services (e.g. email, FTP, Web etc.) going to different service servers/clients in your LAN. The Port Forwarding allows you to re-direct a particular range of service port numbers (from the

Internet/WAN Ports) to a particular LAN IP address.

2.4.2 Virtual Server

You can have different services (e.g. email, FTP, Web etc.) going to different service servers/clients in your LAN. The Virtual Server allows you to re-direct a particular service port number (from the Internet/WAN Port) to a particular LAN IP address and its service port number.

2.4.3 Special Applications

Some applications require multiple connections, such as Internet games, video conferencing, Internet telephony and others. In this section you can configure the router to support these types of applications.

2.4.4 ALG Setting

You can select special applications that need "Application Layer Gateway" to support here.

Click on one of the three NAT selections and proceed to the manual's relevant sub-section.

2.4.1 Port Forwarding

The Port Forwarding allows you to re-direct a particular range of service port numbers (from the Internet/WAN Ports) to a particular LAN IP address. It helps you to host some servers behind the router NAT firewall.

Port Forwarding ?

Entries in this table allow you to automatically redirect common network services to a specific machine behind the NAT firewall. These settings are only necessary if you wish to host some sort of server like a web server or mail server on the private local network behind your Gateway's NAT firewall.

Enable Port Forwarding

| Private IP | Type | Port Range | Comment |
|----------------------|------|---|----------------------|
| <input type="text"/> | Both | <input type="text"/> - <input type="text"/> | <input type="text"/> |

Current Port Forwarding Table:

| Private IP | Type | Port Range | Comment | Select |
|------------|------|------------|---------|--------|
|------------|------|------------|---------|--------|

Parameter

Description

Enable Port Forwarding

Private IP

Enable Port Forwarding

This is the private IP of the server behind the NAT firewall.

Note: You need to give your LAN PC clients a fixed/static IP address for Port Forwarding to work properly.

Type

This is the protocol type to be forwarded. You can choose to forward "TCP" or "UDP" packets only or select "both" to forward both "TCP" and "UDP" packets.

Port Range

The range of ports to be forward to the private IP.

Comment

The description of this setting.

Add Port Forwarding into the table

Fill in the "Private IP", "Type", "Port Range" and "Comment" of the setting to be added and then click "Add". Then this Port Forwarding setting will be added into the "Current Port Forwarding Table" below. If you find any typo before adding it and want to retype again, just click "Clear" and the fields will be cleared.

Remove Port Forwarding into the table

If you want to remove some Port Forwarding settings from the " Current Port Forwarding Table", select the Port Forwarding settings you want to remove in the table and then click "Delete Selected". If you want remove all Port Forwarding settings from the table, just click "Delete All" button. Click "Reset" will clear your current selections.

Click <**Apply**> at the bottom of the screen to save the above configurations. You can now configure other advance sections or start using the router (with the advance settings in place)

2.4.2 Virtual Server

Use the Virtual Server function when you want different servers/clients in your LAN to handle different service/Internet application type (e.g. Email, FTP, Web server etc.) from the Internet. Computers use numbers called port numbers to recognize a particular service/Internet application type. The Virtual Server allows you to re-direct a particular service port number (from the Internet/WAN Port) to a particular LAN private IP address and its service port number. (See Glossary for an explanation on Port number)

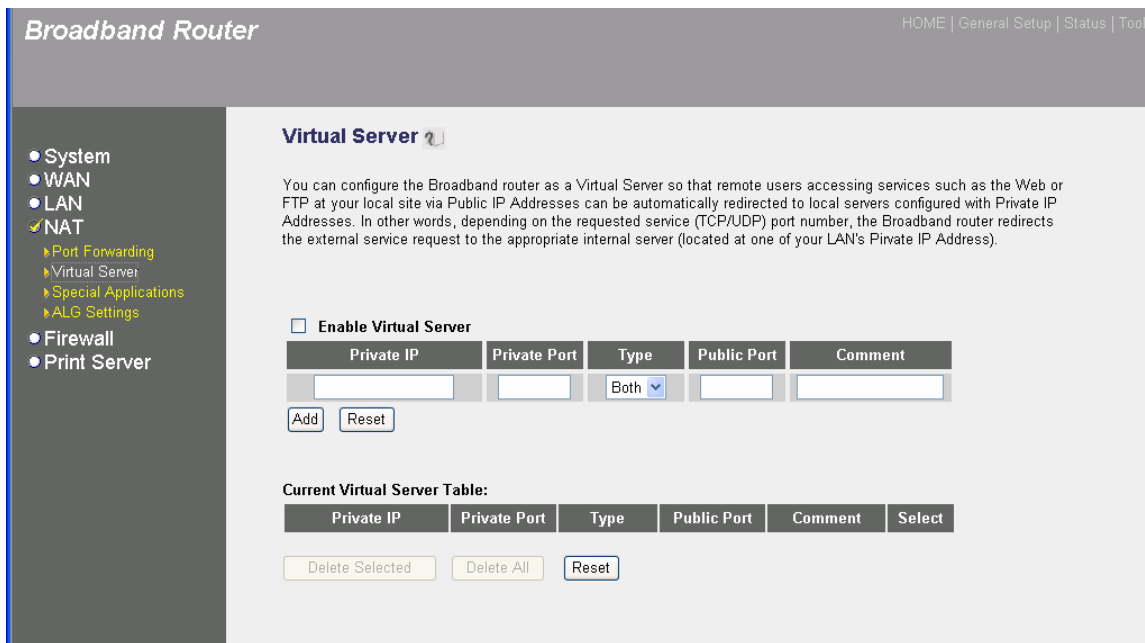

| Parameters | Description |
|-----------------------|---|
| Enable Virtual Server | Enable Virtual Server. |
| Private IP | This is the LAN client/host IP address that the Public Port number packet will be sent to. Note: You need to give your LAN PC clients a fixed/static IP address for Virtual Server to work properly. |
| Private Port | This is the port number (of the above Private IP host) that the below Public Port number will be changed to when the packet enters your LAN (to the LAN Server/Client IP) |
| Type | Select the port number protocol type (TCP, UDP or both). If you are unsure, then leave it to the default both protocol. |
| Public Port | Enter the service (service/Internet application) port number from the Internet that will be re-directed to the above Private IP address host in your LAN Note: Virtual Server function will have priority over the DMZ function if there is a conflict between the Virtual Server and the DMZ settings. |
| Comment | The description of this setting. |
| Add Virtual Server | Fill in the "Private IP", "Private Port", "Type", "Public Port" and "Comment" of the setting to be added and then click "Add". Then this Virtual Server setting will be added into the "Current Virtual Server Table" below. If you find |

any typo before adding it and want to retype again, just click "Clear" and the fields will be cleared.

Remove Virtual Server

If you want to remove some Virtual Server settings from the " Current Virtual Server Table", select the Virtual Server settings you want to remove in the table and then click "Delete Selected". If you want remove all Virtual Server settings from the table, just click "Delete All" button. Click "Reset" will clear your current selections.

Click <**Apply**> at the bottom of the screen to save the above configurations. You can now configure other advance sections or start using the router (with the advance settings in place)

Example: Virtual Server

The diagram below demonstrates one of the ways you can use the Virtual Server function. Use the Virtual Server when you want the web server located in your private LAN to be accessible to Internet users. The configuration below means that any request coming form the Internet to access your web server will be translated to your LAN's web server (192.168.2.2). **Note:** For the virtual server to work properly Internet/remote users must know your global IP address. (For websites you will need to have a fixed/static global/public IP address)

Configuration

Private IP: 192.168.2.2

Private Port: 80

Type: TCP

Public Port: 80

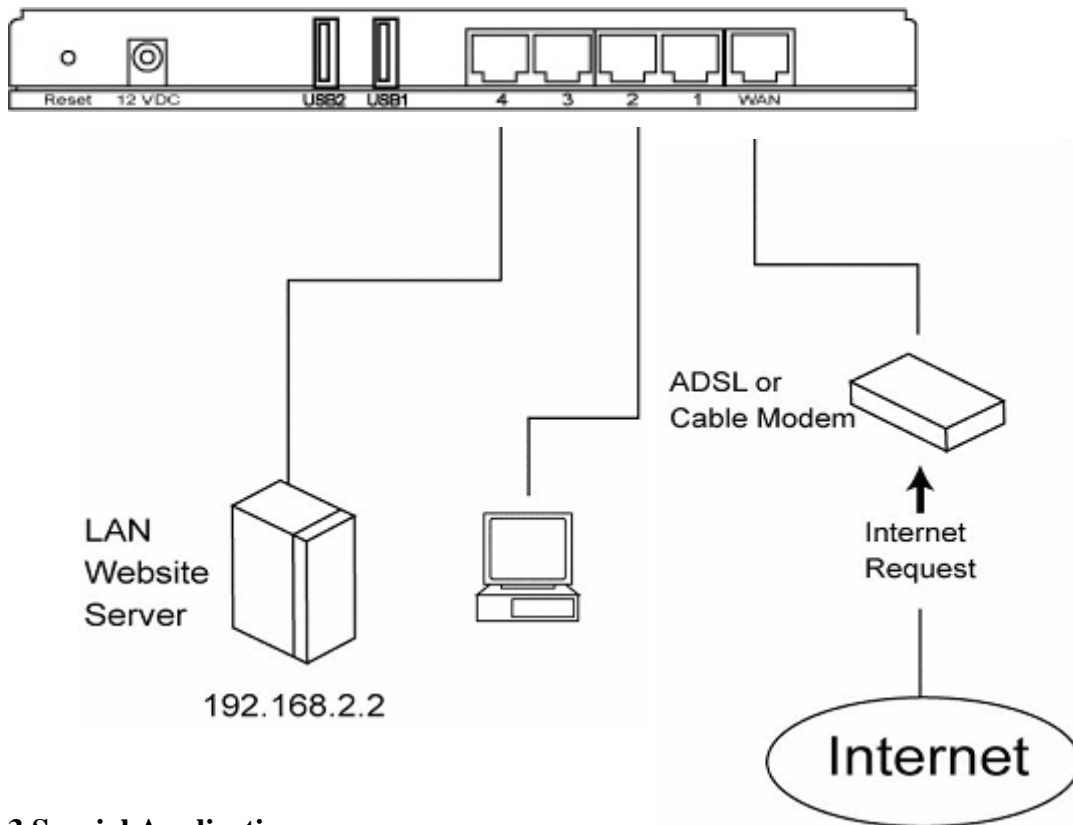

2.4.3 Special Applications

Some applications require multiple connections, such as Internet games, video conferencing, Internet telephony and others. In this section you can configure the router to support multiple connections for these types of applications.

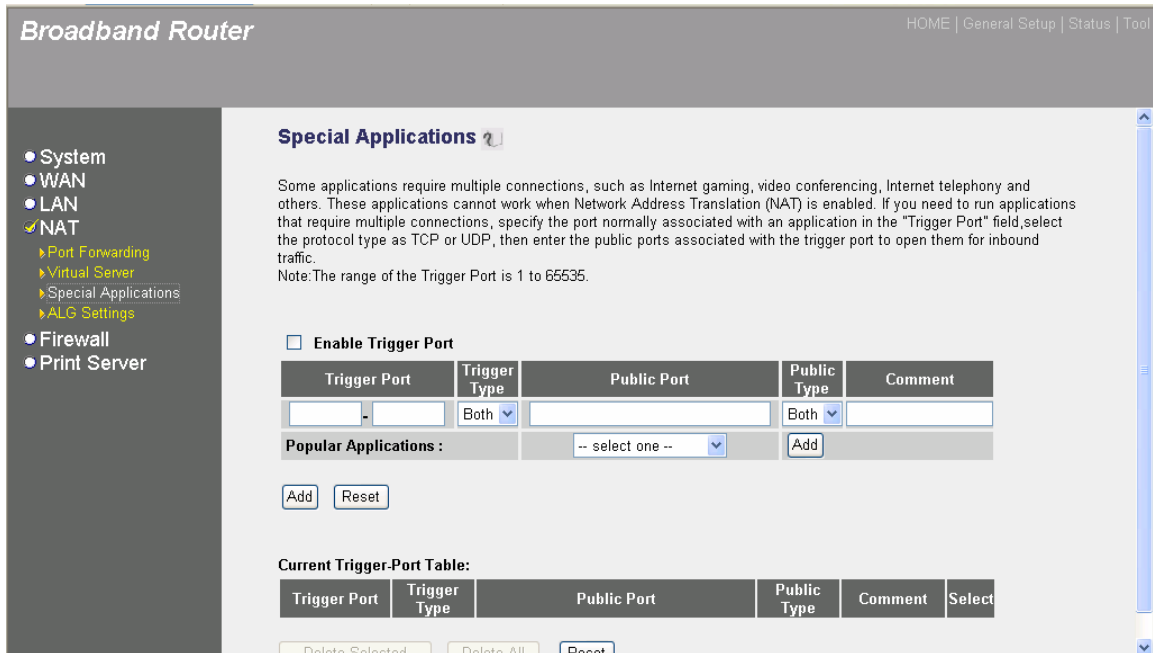

| Parameters | Description |
|-------------------------|--|
| Enable Trigger Port | Enable the Special Application function. |
| Trigger Port | This is the out going (Outbound) range of port numbers for this particular application |
| Trigger Type | Select whether the outbound port protocol is “TCP”, “UDP” or both. |
| Public Port | Enter the In-coming (Inbound) port or port range for this type of application (e.g. 2300-2400, 47624) Note: Individual port numbers are separated by a comma (e.g. 47624, 5775, 6541 etc.). To input a port range use a “dash” to separate the two port number range (e.g. 2300-2400) |
| Public Type | Select the Inbound port protocol type: “TCP”, “UDP” or both |
| Comment | The description of this setting. |
| Popular applications | This section lists the more popular applications that require multiple connections. Select an application from the Popular Applications selection. Once you have selected an application, click the Add button. This will automatically copy the Port Trigger information required for this popular application in into the input fields. |
| Add Special Application | Fill in the "Trigger Port", "Trigger Type", “Public Port”, "Public Type", "Public Port" and "Comment" of the setting to be added and then click "Add". Then this Special |

Application setting will be added into the "Current Trigger-Port Table" below. If you find any typo before adding it and want to retype again, just click "Clear" and the fields will be cleared.

If you want to add a popular application, select one "Popular Application" and then click "Add".

Remove Special Application If you want to remove some Special Application settings from the "Current Trigger-Port Table", select the Special Application settings you want to remove in the table and then click "Delete Selected". If you want remove all Special Application settings from the table, just click "Delete All" button. Click "Reset" will clear your current selections.

Click **<Apply>** at the bottom of the screen to save the above configurations. You can now configure other advance sections or start using the router (with the advance settings in place)

Example: Special Applications

If you need to run applications that require multiple connections, then specify the port (outbound) normally associated with that application in the "Trigger Port" field. Then select the protocol type (TCP or UDP) and enter the public ports associated with the trigger port to open them up for inbound traffic.

Example:

| ID | Trigger Port | Trigger Type | Public Port | Public Type | Comment |
|----|--------------|--------------|------------------|-------------|---------------|
| 1 | 28800 | UDP | 2300-2400, 47624 | TCP | MSN Game Zone |
| 2 | 6112 | UDP | 6112 | UDP | Battle.net |

In the example above, when a user trigger's port 28800 (outbound) for MSN Game Zone then the router will allow incoming packets for ports 2300-2400 and 47624 to be directed to that user.

Note: Only one LAN client can use a particular special application at a time.

2.4.4 ALG Settings

You can select applications that need "Application Layer Gateway" to support.

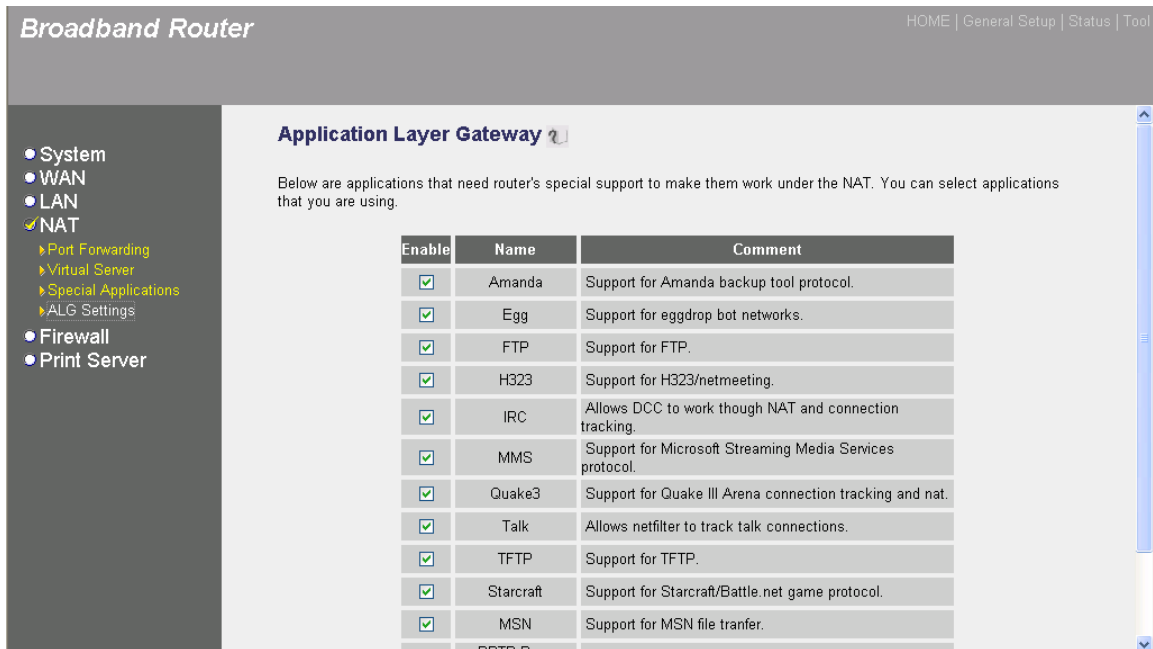

| Parameters | Default | Description |
|------------|---------|---|
| Enable | | You can select to enable “Application Layer Gateway” of an application and then the router will let that application correctly pass though the NAT gateway. |

Click **<Apply>** at the bottom of the screen to save the above configurations. You can now configure other advance sections or start using the router (with the advance settings in place)

2.5 Firewall

The Broadband router provides extensive firewall protection by restricting connection parameters, thus limiting the risk of hacker attack, and defending against a wide array of common Internet attacks. However, for applications that require unrestricted access to the Internet, you can configure a specific client/server as a Demilitarized Zone (DMZ).

Note: To enable the Firewall settings select **Enable** and click **Apply**

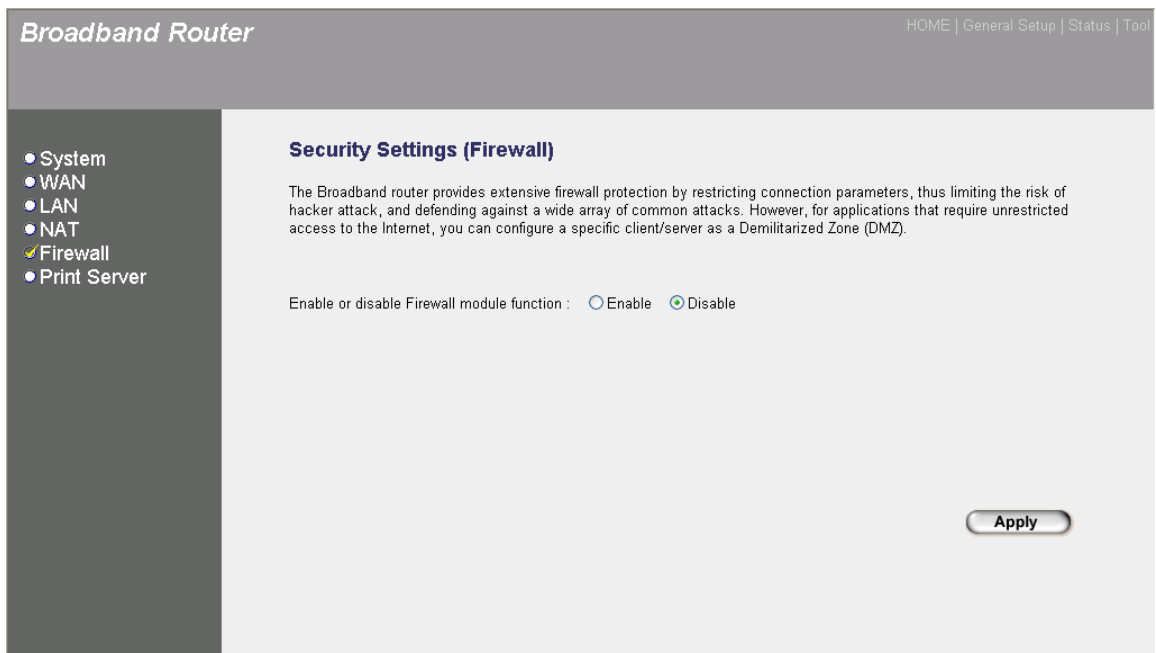

| Parameters | Description |
|----------------------|--|
| 2.5.1 Access Control | Access Control allows you to specify which hosts users can or cannot have access to certain Internet applications |
| 2.5.2 URL Blocking | URL Blocking allow you to specify which URLs can not be accessed by users. |
| 2.5.3 DoS | The Broadband router's firewall can block common hacker attacks and can log the attack activities. |
| 2.5.4 DMZ | The DMZ function allows you to re-direct all packets going to your WAN port IP address to a particular IP address in your LAN. |

Click on one of the firewall selections and proceed to the manual's relevant sub-section

2.5.1 Access Control

If you want to restrict users from accessing certain Internet applications/services (e.g. Internet websites, email, FTP etc.), then this is the place to set that configuration. Access Control allows users to define the traffic type permitted in your LAN. You can control which PC client can have access to these services.

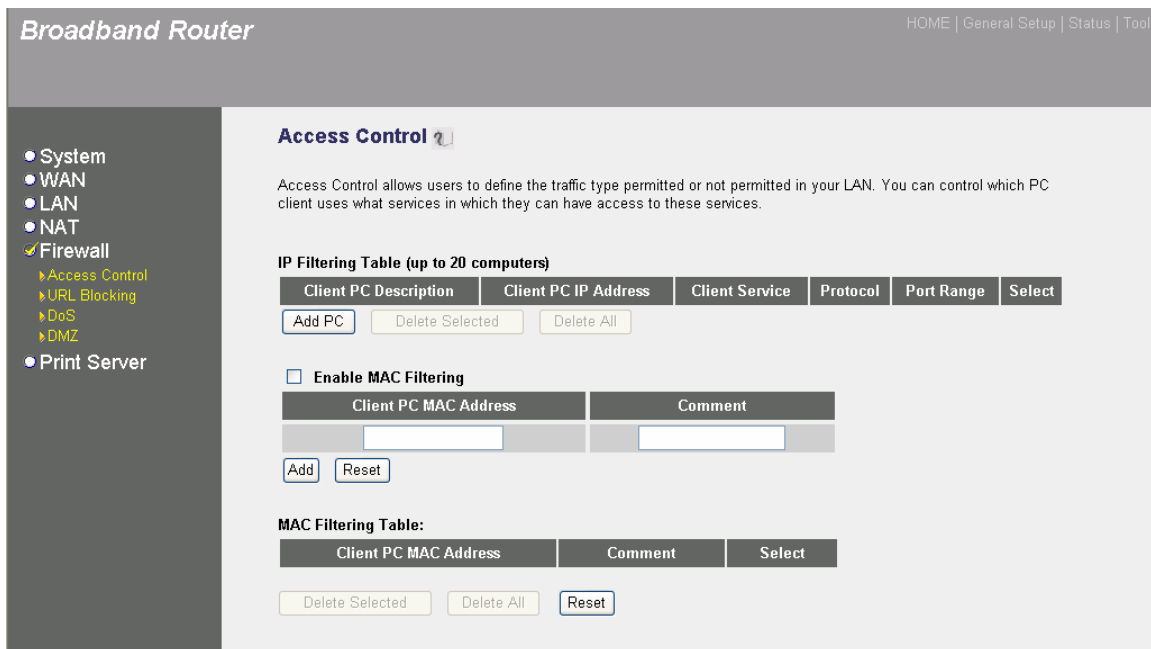

| Parameters | Description |
|--|--|
| Filter client PCs by IP | Fill “IP Filtering Table” to filter PC clients by IP. |
| Add PC | You can click Add PC to add an access control rule for users by IP addresses. |
| Remove PC | If you want to remove some PC from the "IP Filtering Table", select the PC you want to remove in the table and then click "Delete Selected". If you want remove all PCs from the table, just click "Delete All" button. |
| Filter client PC by MAC address | Check “Enable MAC Filtering” to enable MAC Filtering. |
| Add PC | Fill in “Client PC MAC Address” and “Comment” of the PC that is allowed to access the Internet, and then click “Add”. If you find any typo before adding it and want to retype again, just click "Reset" and the fields will be cleared. |
| Remove PC | If you want to remove some PC from the "MAC Filtering Table", select the PC you want to remove in the table and then click "Delete Selected". If you want remove all PCs from the table, just click |

"Delete All" button. If you want to clear the selection and re-select again, just click "Reset".

You can now configure other advance sections or start using the router (with the advance settings in place)

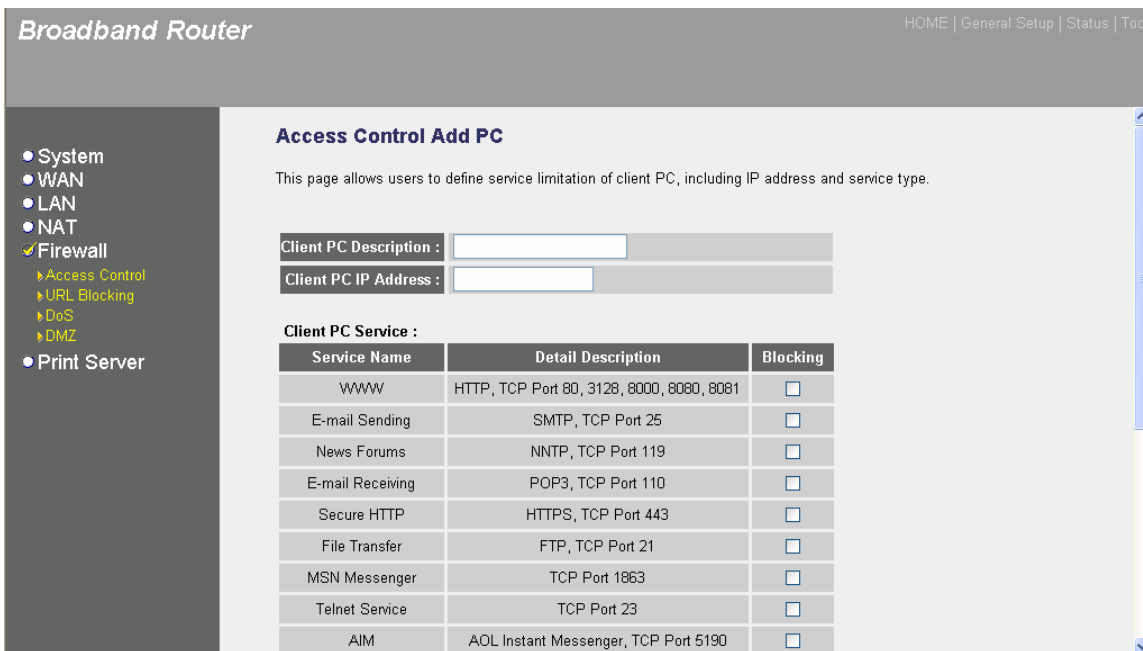

Add PC

Parameters

Description

Client PC Description

The description for this client PC rule.

Client PC IP Addresses

Enter the IP address range that you wish to apply this Access Control rule. This is the user's IP address(es) that you wish to setup an Access Control rule. You can select a range of users simply by inputting the starting users' IP address and the last user's IP address in the appropriate boxes. If you want to select only one user then input the user's IP address in both boxes.

Note: You need to give your LAN PC clients a fixed/static IP address for the Access Control rule to work properly.

Client PC Service

You can block the clients from accessing some Internet services by checking the services you want to block.

Protocol

This allows you to select UDP, TCP or both protocol type you want to block.

Port Range

You can assign up to five port ranges. The router will block clients from accessing Internet services that use these ports.

Apply Changes

Click “Apply Changes” to save the setting.

Reset

Click “Reset” to clear all fields.

Click **<Apply Changes>** at the bottom of the screen to save the above configurations. You can now configure other advance sections or start using the router (with the advance settings in place)

Example: Access Control

In the example below, LAN client A can only access websites that use Port 80. However, LAN client B is able to access websites and any other service that uses ports between 80 and 999.

Configuration

IP: 192.168.2.2

Port: 80-80

Configuration

IP: 192.168.2.3

Port: 80-999

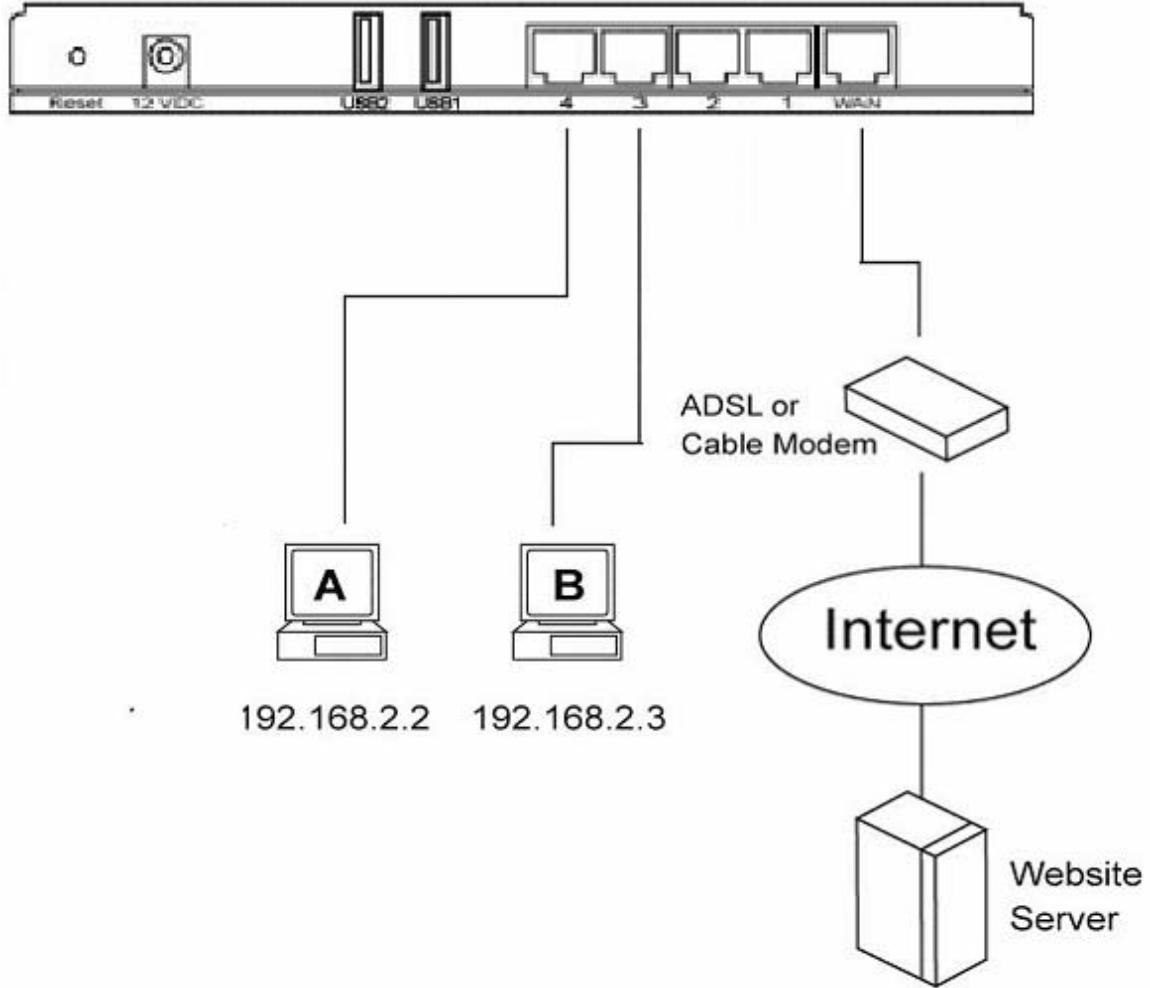

2.5.2 URL Blocking

You can block access to some Web sites from particular PCs by entering a full URL address or just keyword of the Web site.

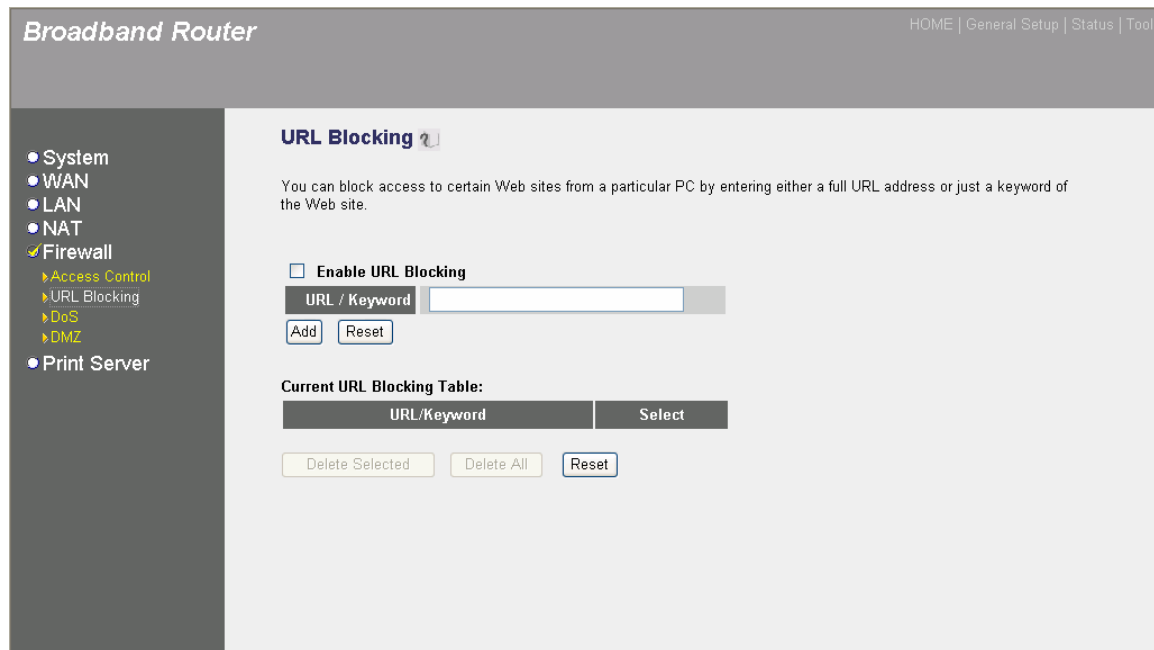

| Parameters | Description |
|---------------------|---|
| Enable URL Blocking | Enable/disable URL Blocking |
| Add URL Keyword | Fill in “URL/Keyword” and then click “Add”. You can enter the full URL address or the keyword of the web site you want to block. If you find any typo before adding it and want to retype again, just click "Reset" and the field will be cleared. |
| Remove URL Keyword | If you want to remove some URL keyword from the "Current URL Blocking Table", select the URL keyword you want to remove in the table and then click "Delete Selected". If you want remove all URL keyword from the table, just click "Delete All" button. If you want to clear the selection and re-select again, just click “Reset”. |

You can now configure other advance sections or start using the router (with the advance settings in place)

2.5.3 Denial of Service (DoS)

The Broadband router's firewall can block common hacker attacks, including Denial of Service, Ping of Death, Port Scan and Sync Flood. If Internet attacks occur the router can log the events.

Broadband Router HOME | General Setup | Status | Tool

Denial of Service ?

The Broadband router's firewall can block common hacker attacks, including DoS, Discard Ping from WAN and Port Scan.

Denial of Service Feature

| | |
|-------------------------|--------------------------|
| Ping of Death : | <input type="checkbox"/> |
| Discard Ping From WAN : | <input type="checkbox"/> |
| Port Scan : | <input type="checkbox"/> |
| Sync Flood : | <input type="checkbox"/> |

Advance Settings

Apply Cancel

| Parameters | Description |
|------------------------------------|---|
| Intrusion Detection Feature | |
| Ping of Death | Protections from Ping of Death attack |
| Discard Ping From WAN | The router's WAN port will not respond to any Ping requests |
| Port Scan | Protection the router from Port Scan. |
| Sync Flood | Protection the router from Sync Flood attack. |

Click **<Apply>** at the bottom of the screen to save the above configurations. You can now configure other advance sections or start using the router (with the advance settings in place)

2.5.4 DMZ

If you have a local client PC that cannot run an Internet application (e.g. Games) properly from behind the NAT firewall, then you can open the client up to unrestricted two-way Internet access by defining a DMZ Host. The DMZ function allows you to re-direct all packets going to your WAN port IP address to a particular IP address in your LAN. The difference between the virtual server and the DMZ function is that the virtual server re-directs a particular service/Internet application

(e.g. FTP, websites) to a particular LAN client/server, whereas DMZ re-directs all packets (regardless of services) going to your WAN IP address to a particular LAN client/server.

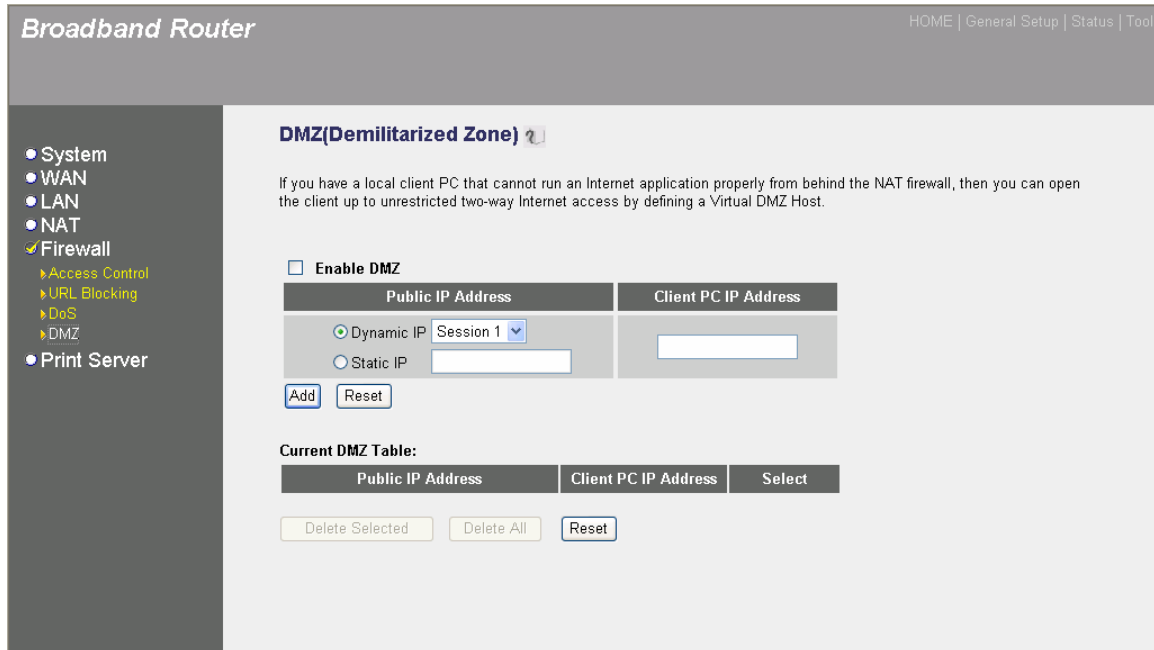

| Parameters | Description |
|----------------------|---|
| Enable DMZ | Enable/disable DMZ Note: If there is a conflict between the Virtual Server and the DMZ setting, then Virtual Server function will have priority over the DMZ function. |
| Public IP Address | The IP address of the WAN port or any other Public IP addresses given to you by your ISP |
| Client PC IP Address | Input the IP address of a particular host in your LAN that will receive all the packets originally going to the WAN port/Public IP address above Note: You need to give your LAN PC clients a fixed/static IP address for DMZ to work properly. |

You can now configure other advance sections or start using the router (with the advance settings in place)

Chapter 3

Status

The Status section allows you to monitor the current status of your router. You can use the Status page to monitor: the connection status of the Broadband router's WAN/LAN interfaces, the current firmware and hardware version numbers, any illegal attempts to access your network, and information on all DHCP client PCs currently connected to your network.

| Parameters | Description |
|----------------------------|---|
| 3.1 Status and Information | Shows the router's system information |
| 3.2 Internet Connection | View the Broadband router's current Internet connection status and other related information |
| 3.3 Device Status | View the Broadband router's current setting status |
| 3.4 Security Log | View any attempts that have been made to illegally gain access to your network. |
| 3.5 DHCP Client Table | View your LAN client's information that is currently linked to the Broadband router's DHCP server |
| 3.6 Statistics | Shows the statistics |

Select one of the above five Status selections and proceed to the manual's relevant sub-section

3.1 Status and Information

The Status and Information section allows you to view the router's system information

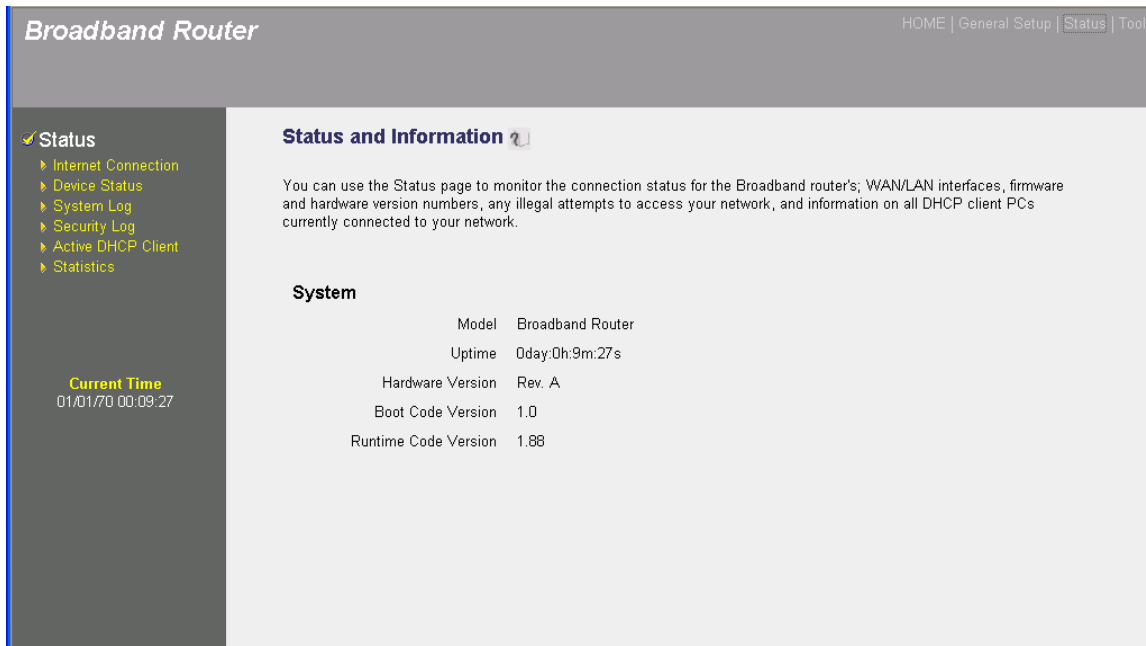

| Parameters | Description |
|-------------|--|
| Information | You can see the router's system information such as the router's: LAN MAC Address, WAN MAC Address, Hardware version, Serial Number, Boot code Version, Runtime code Version |

3.2 Internet Connection

View the Broadband router's current Internet connection status and other related information

Broadband Router HOME | General Setup | Status | Tools

Status

- ▶ Internet Connection
- ▶ Device Status
- ▶ System Log
- ▶ Security Log
- ▶ Active DHCP Client
- ▶ Statistics

Current Time
01/01/70 00:09:27

Internet Connection ?

View the current internet connection status and related information.

| | |
|----------------------|-----------------------|
| Attain IP Protocol : | Dynamic IP disconnect |
| IP Address : | |
| Subnet Mask : | |
| Default Gateway : | 0.0.0.0 |
| MAC Address : | 00:06:1B:DA:3D:AA |
| Primary DNS : | |
| Secondary DNS : | |

| Parameters | Description |
|---------------------|--|
| Internet Connection | This page displays whether the WAN port is connected to a Cable/DSL connection. It also displays the router's WAN port: WAN IP address, Subnet Mask , and ISP Gateway as well as the Primary DNS and Secondary DNS being used. |

3.3 Device Status

View the Broadband router's current configuration settings. The Device Status displays the configuration settings you've configured in the **Quick Setup Wizard/General Setup** section.

Broadband Router HOME | General Setup | Status | Tool

Status

- ▶ Internet Connection
- ▶ Device Status
- ▶ System Log
- ▶ Security Log
- ▶ Active DHCP Client
- ▶ Statistics

Current Time
01/01/70 00:09:27

Device Status ?

View the current setting status of this device.

| LAN Configuration | |
|-------------------|-------------------|
| IP Address | 192.168.2.1 |
| Subnet Mask | 255.255.255.0 |
| DHCP Server | Enabled |
| MAC Address | 00:0e:2e:00:01:26 |

| Parameters | Description |
|---------------|---|
| Device Status | This page shows the Broadband router's current device settings. This page displays the Broadband router LAN port's current LAN IP Address , MAC Address and Subnet Mask . It also shows whether the DHCP Server function is enabled/disabled. |

[3.4 System Log](#)

View any attempts that have been made to illegally gain access to your network.

Broadband Router HOME | General Setup | Status | Tools

Status

- ▶ Internet Connection
- ▶ Device Status
- ▶ System Log
- ▶ Security Log
- ▶ Active DHCP Client
- ▶ Statistics

Current Time
01/01/70 00:09:27

System Log ?

View the system operation information. You can see the system start up time, connection process...etc. here.

```
Jan 1 00:00:22 udhcpd: udhcp server (v0.9.9-pre) started
Jan 1 00:00:24 udhcpd: udhcp client started
Jan 1 00:00:50 udhcpd: sending OFFER of 192.168.2.100
Jan 1 00:00:50 udhcpd: sending ACK to 192.168.2.100
```

| Parameters | Description |
|------------|---|
| System Log | <p>This page shows the current system log of the Broadband router. It displays any illegal attempts to access your network. At the bottom of the page, the system log can be saved <Save> to a local file for further processing or the security log can be cleared <Clear> or it can be refreshed <Refresh> to get the most updated situation. When the system is powered down, the security log will disappear if not saved to a local file.</p> |

[3.5 Security Log](#)

View any attempts that have been made to illegally gain access to your network.

Broadband Router HOME | General Setup | Status | Tool

✔ **Status**

- ▶ Internet Connection
- ▶ Device Status
- ▶ System Log
- ▶ Security Log
- ▶ Active DHCP Client
- ▶ Statistics

Current Time
01/01/70 00:09:27

Security Log ?

View any attempts that have been made to illegally gain access to your network.

```

[1970-01-01 00:00:23]: [WAN]: start Dynamic IP
[1970-01-01 00:02:40]: [SNTP]: connect to TimeServer 192.43.244.18 ...
[1970-01-01 00:02:41]: [SNTP]: connect fail!!
[1970-01-01 00:03:51]: [SNTP]: connect to TimeServer 192.43.244.18 ...
[1970-01-01 00:03:51]: [SNTP]: connect fail!!

```

| Parameters | Description |
|--------------|--|
| Security Log | <p>This page shows the current security log of the Broadband router. It displays any illegal attempts to access your network.</p> <p>At the bottom of the page, the security log can be saved <Save> to a local file for further processing or the security log can be cleared <Clear> or it can be refreshed <Refresh> to get the most updated situation. When the system is powered down, the security log will disappear if not saved to a local file.</p> |

[3.6 Active DHCP Client Table](#)

View your LAN client's information that is currently linked to the Broadband router's DHCP server

Broadband Router HOME | General Setup | Status | Tools

✔ **Status**

- ▶ Internet Connection
- ▶ Device Status
- ▶ System Log
- ▶ Security Log
- ▶ Active DHCP Client
- ▶ Statistics

Current Time
01/01/70 00:09:27

Active DHCP Client ?

This table shows the assigned IP address, MAC address and time expired for each DHCP leased client.

| IP Address | MAC Address | Time Expired(s) |
|---------------|-------------------|-----------------|
| 192.168.2.100 | 00:06:1b:da:3d:aa | forever |

| Parameters | Description |
|-----------------|---|
| DHCP Client Log | This page shows all DHCP clients (LAN PCs) currently connected to your network. The “Active DHCP Client Table” displays the IP address and the MAC address and Time Expired of each LAN Client. Use the Refresh button to get the most updated situation |

[3.7 Statistics](#)

View the statistics of packets sent and received on WAN and LAN.

✓ Status

- ▶ Internet Connection
- ▶ Device Status
- ▶ System Log
- ▶ Security Log
- ▶ Active DHCP Client
- ▶ Statistics

Current Time
01/01/70 00:09:27

Statistics ?

This page shows the packet counters for transmission and reception regarding to networks.

| | | |
|--------------|------------------|-----|
| Ethernet LAN | Sent Packets | 313 |
| | Received Packets | 390 |
| Ethernet WAN | Sent Packets | 33 |
| | Received Packets | 0 |

Refresh

Parameters

Description

Statistics

Shows the counters of packets sent and received on WAN and LAN.

Chapter 4

Tool

This page includes the basic configuration tools, such as Configuration Tools (save or restore configuration settings), Firmware Upgrade (upgrade system firmware) and Reset.

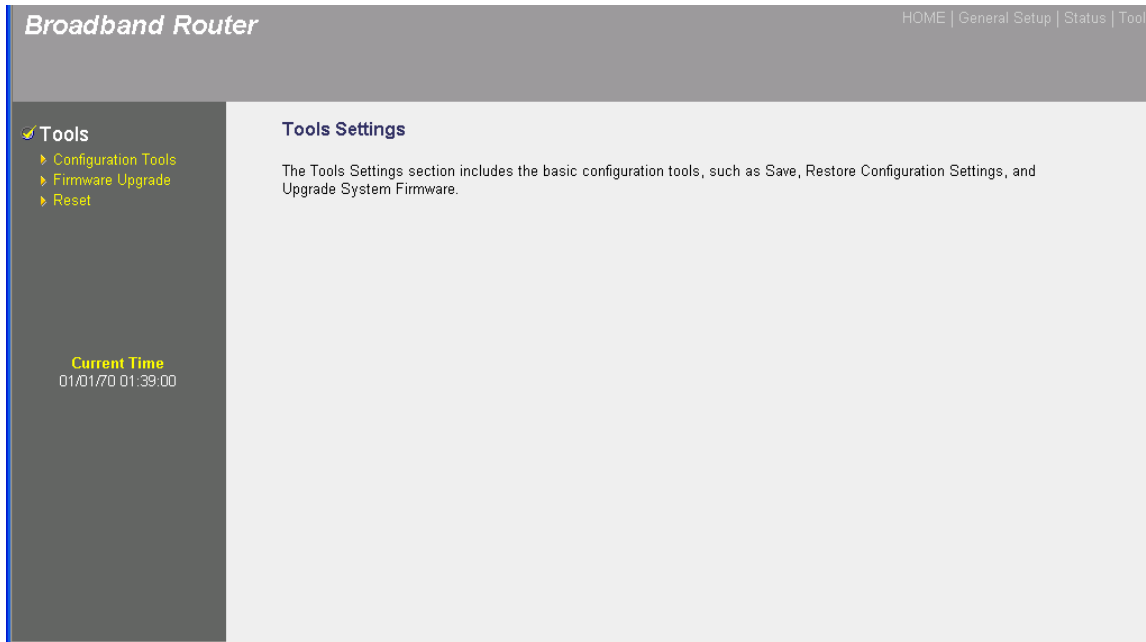

| Parameters | Description |
|-------------------------|---|
| 4.1 Configuration Tools | You can save the router's current configuration, restore the router's saved configuration files and restore the router's factory default settings |
| 4.2 Firmware Upgrade | This page allows you to upgrade the router's firmware |
| 4.3 Reset | You can reset the router's system should any problem exist |

Select one of the above three **Tools Settings** selection and proceed to the manual's relevant sub-section

[4.1 Configuration Tools](#)

The Configuration Tools screen allows you to save (**Backup**) the router's current configuration setting. Saving the configuration settings provides an added protection and convenience should problems occur with the router and you have to reset to factory default. When you save the configuration setting (Backup) you can re-load the saved configuration into the router through the

Restore selection. If extreme problems occur you can use the **Restore to Factory Defaults** selection, this will set all configurations to its original default settings (e.g. when you first purchased the router).

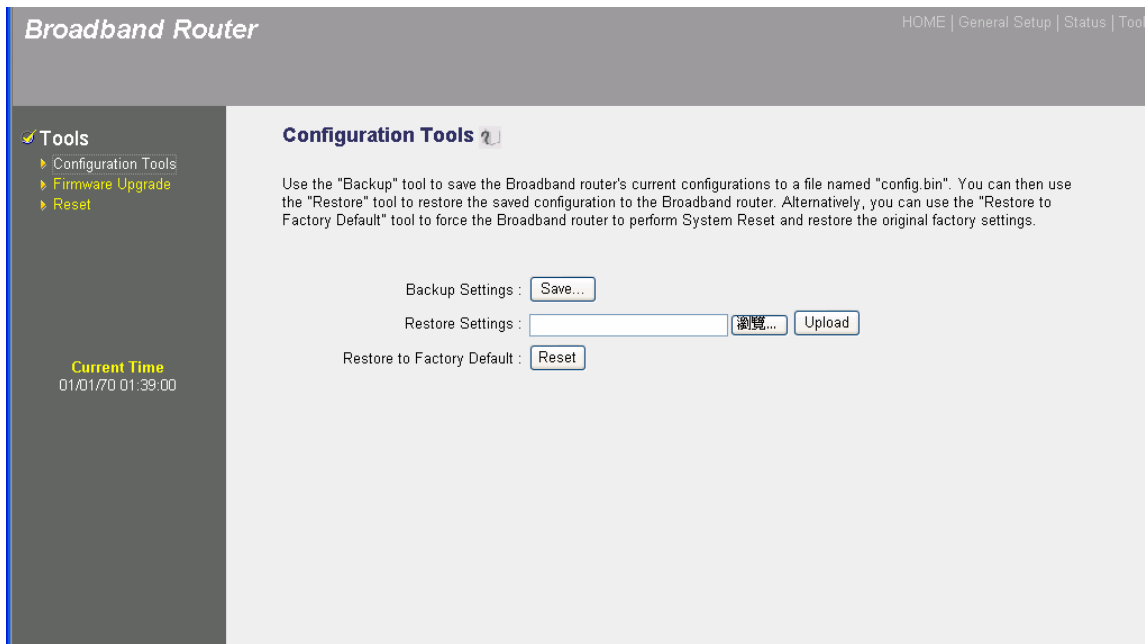

| Parameters | Description |
|---------------------|--|
| Configuration Tools | Use the " Backup " tool to save the Broadband router current configuration to a file named "config.bin" on your PC. You can then use the " Restore " tool to restore the saved configuration to the Broadband router. Alternatively, you can use the " Restore to Factory Defaults " tool to force the Broadband router to perform a power reset and restore the original factory settings. |

[4.2 Firmware Upgrade](#)

This page allows you to upgrade the router's firmware

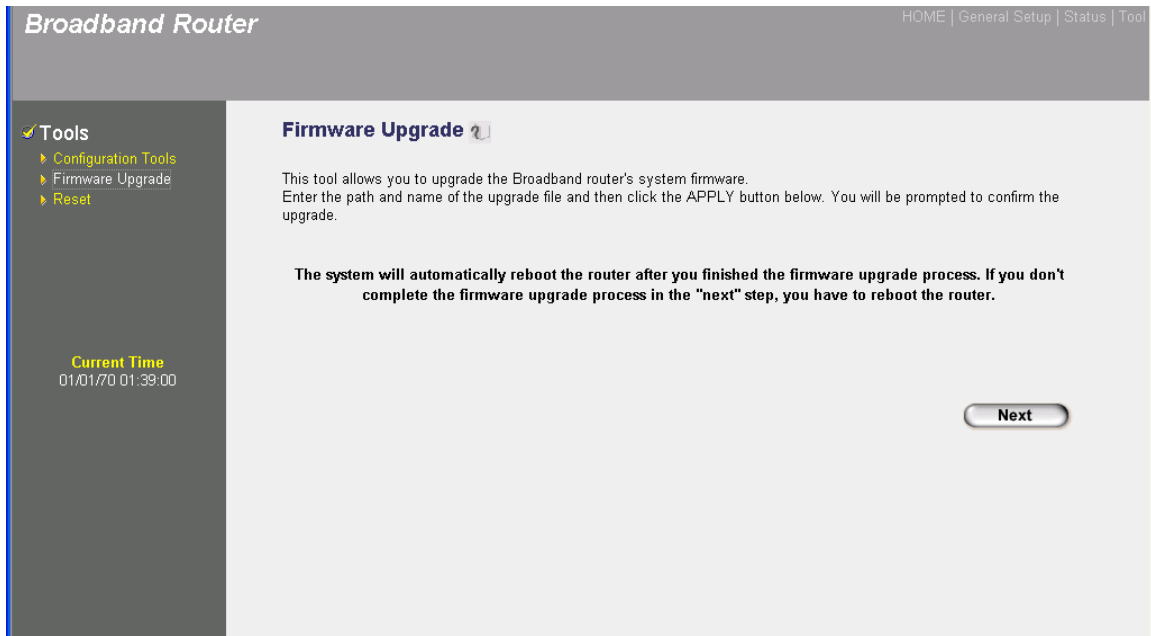

| Parameters | Description |
|------------------|---|
| Firmware Upgrade | This tool allows you to upgrade the Broadband router's system firmware. To upgrade the firmware of your Broadband router, you need to download the firmware file to your local hard disk, and enter that file name and path in the appropriate field on this page. You can also use the Browse button to find the firmware file on your PC. |

Once you've selected the new firmware file, click **<Apply>** at the bottom of the screen to start the upgrade process. (You may have to wait a few minutes for the upgrade to complete). Once the upgrade is complete you can start using the router.

[4.3 Reset](#)

You can reset the router's system should any problem exist. The reset function essentially Re-boots your router's system

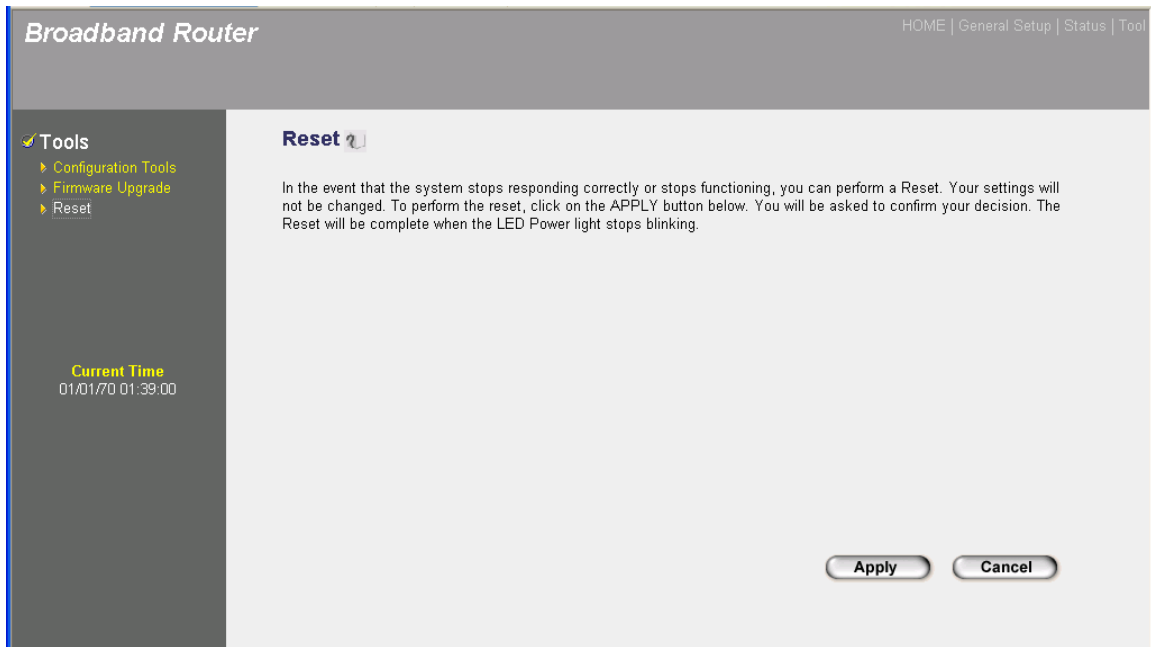

| Parameters | Description |
|------------|--|
| Reset | In the event that the system stops responding correctly or in some way stops functioning, you can perform a reset. Your settings will not be changed. To perform the reset, click on the <APPLY> button. You will be asked to confirm your decision. The reset will be complete when the power light stops blinking. Once the reset process is complete you may start using the router again. |

Chapter 5

5.1 Install Print Server Network Driver

1. Execute Client.exe and the “PrintServer Network driver Setup program” window will be displayed.

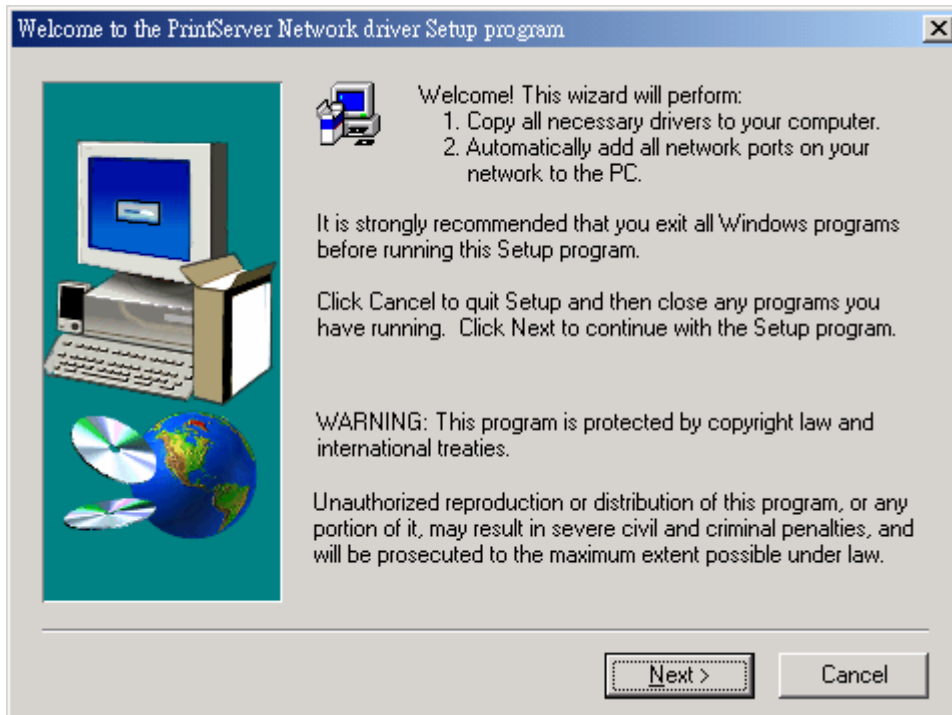

2. Click “Next” and specify the destination folder where the utility will be installed.

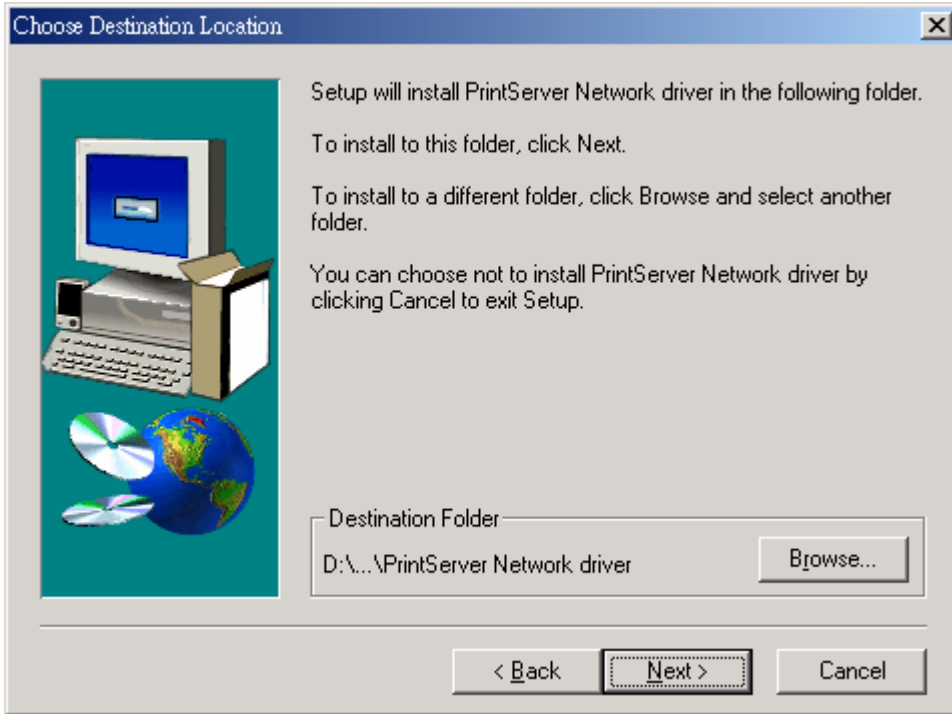

3. Click “Next” and specify the program folder where the program icons will be added.

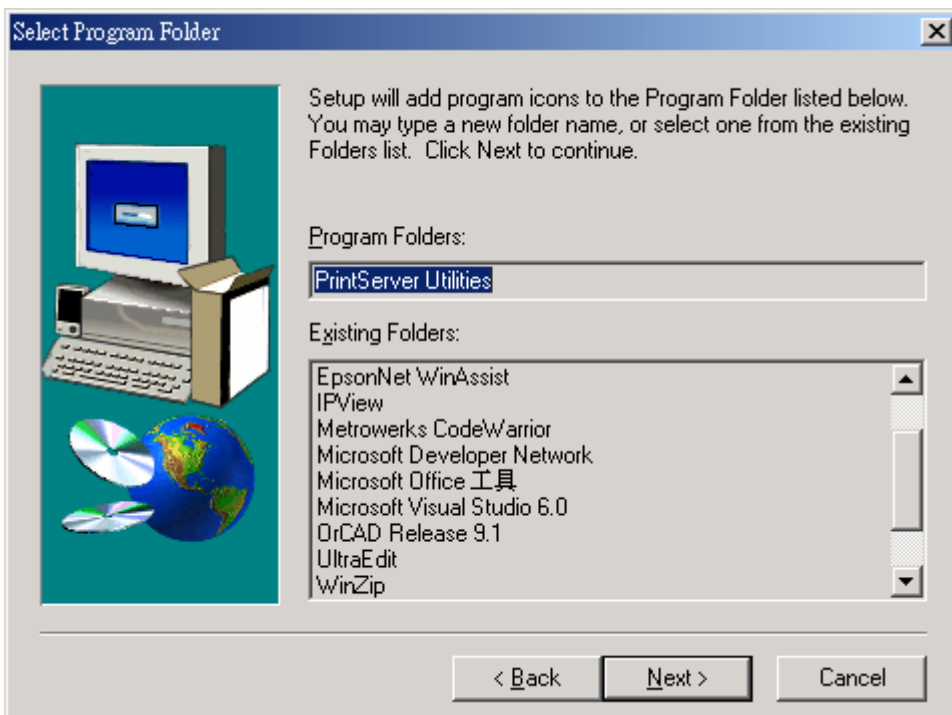

4. Click “Next” to start installation.

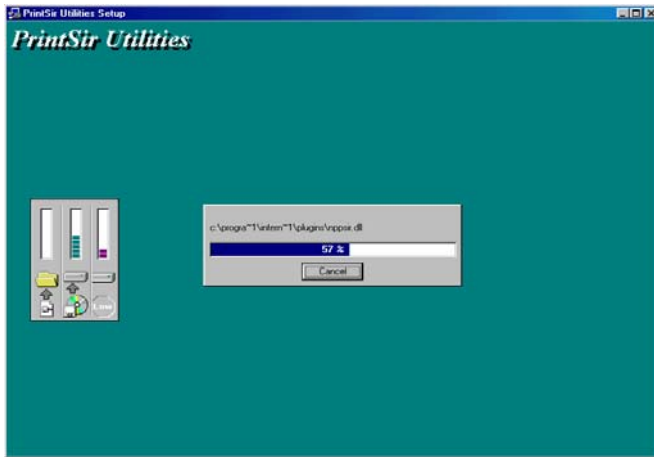

- In a while, the program will finish installing all the utilities and drivers. Thus far you have completed the installation phase and prepare to use the print server.

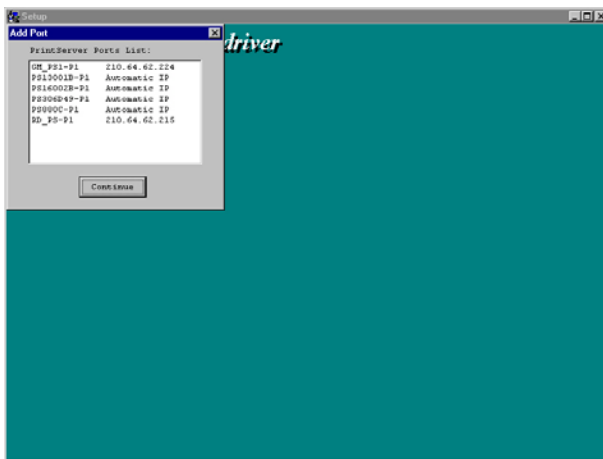

- Click “Continue”, and all the print server’s network ports detected on the network will be added to your PC.



7. Finally, the “Installation complete” window is displayed to indicate that the Client Installation procedure is finished.

5.2 Add a Network Printer

After installing the print server client tool, you can then perform the standard “Add Printer” procedure to add network printer to your PC.

1. Click “Start” button, choose “Setting → Printers”.
2. Double click “Add New Printer”.

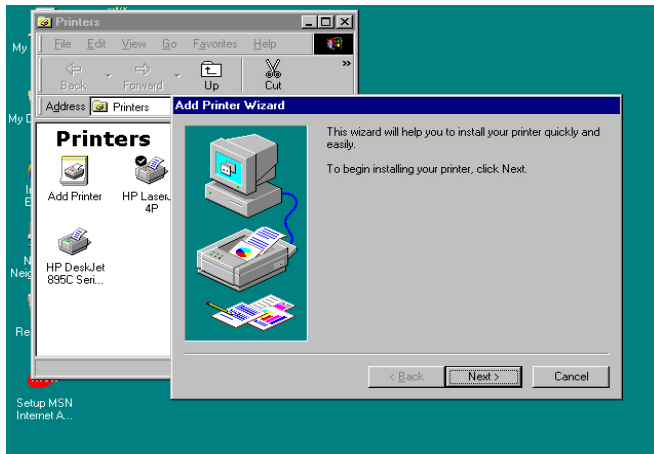

3. Select “Local Printer” and click “Next”.



4. Select the suitable printer manufacturer and model, then click “Next”.

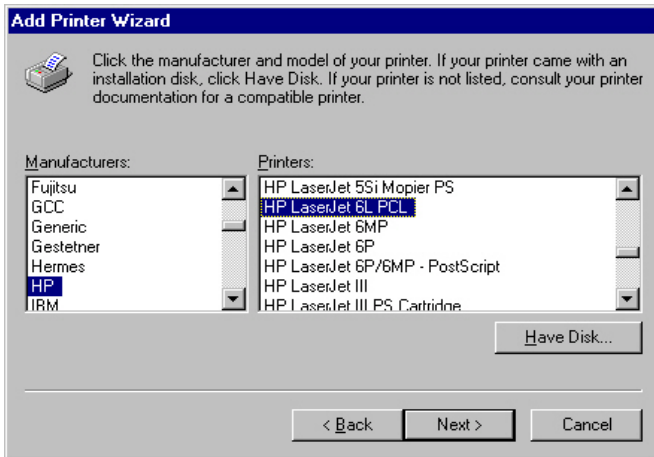

5. Choose print server's remote port which has been created in the previous client tools installation process and click "Next".

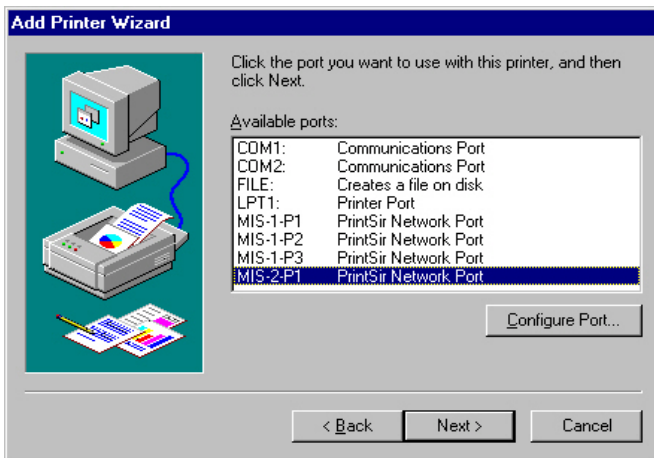

6. Complete the rest of the questions to finish the network printer setup.

Appendix A

How to Manually find your PC's IP and MAC address

- 1) In Window's open the Command Prompt program

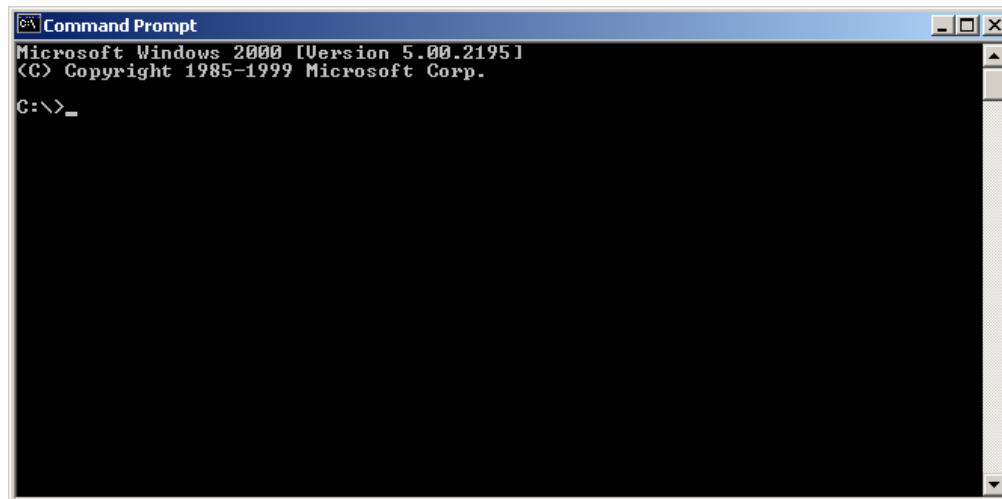

```
Command Prompt
Microsoft Windows 2000 [Version 5.00.2195]
(C) Copyright 1985-1999 Microsoft Corp.
C:\>_
```

- 2) Type **ipconfig /all** and <enter>

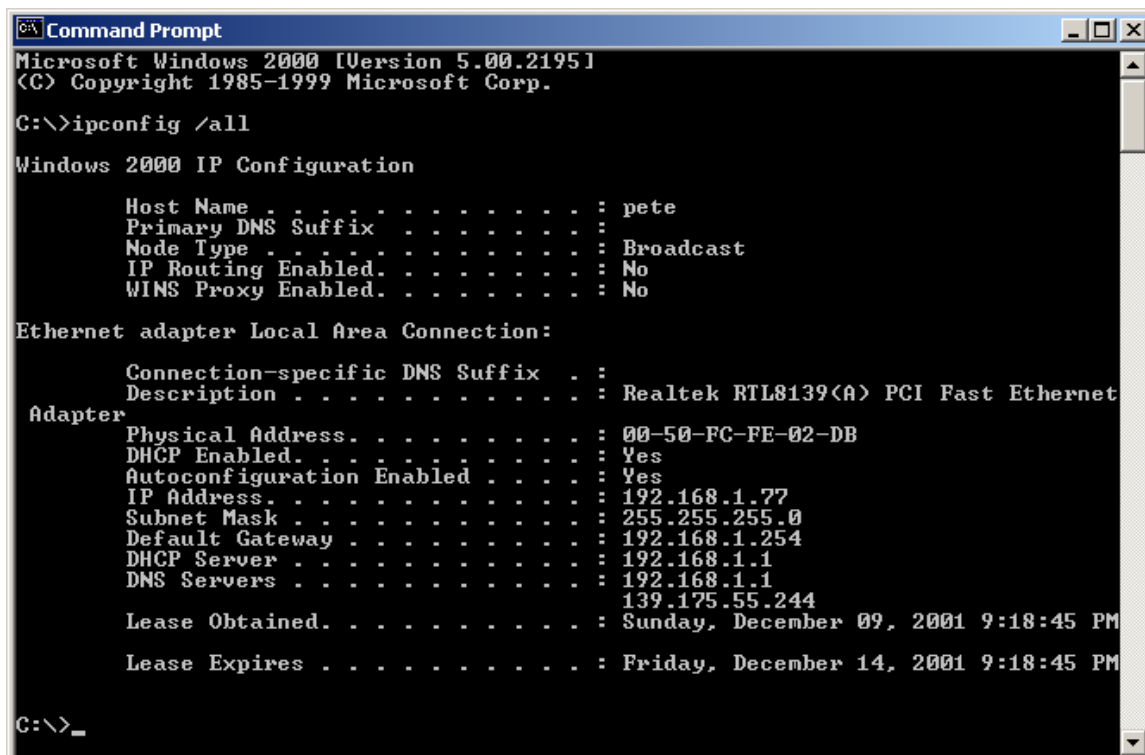

```
Command Prompt
Microsoft Windows 2000 [Version 5.00.2195]
(C) Copyright 1985-1999 Microsoft Corp.
C:\>ipconfig /all

Windows 2000 IP Configuration

    Host Name . . . . . : pete
    Primary DNS Suffix . . . . . :
    Node Type . . . . . : Broadcast
    IP Routing Enabled. . . . . : No
    WINS Proxy Enabled. . . . . : No

Ethernet adapter Local Area Connection:

    Connection-specific DNS Suffix . :
    Description . . . . . : Realtek RTL8139(A) PCI Fast Ethernet
Adapter
    Physical Address. . . . . : 00-50-FC-FE-02-DB
    DHCP Enabled. . . . . : Yes
    Autoconfiguration Enabled . . . . . : Yes
    IP Address. . . . . : 192.168.1.77
    Subnet Mask . . . . . : 255.255.255.0
    Default Gateway . . . . . : 192.168.1.254
    DHCP Server . . . . . : 192.168.1.1
    DNS Servers . . . . . : 192.168.1.1
                          139.175.55.244
    Lease Obtained. . . . . : Sunday, December 09, 2001 9:18:45 PM
    Lease Expires . . . . . : Friday, December 14, 2001 9:18:45 PM

C:\>_
```

- Your PC's IP address is the one entitled **IP address** (192.168.1.77)
- The router's IP address is the one entitled **Default Gateway** (192.168.1.254)
- Your PC's MAC Address is the one entitled **Physical Address** (00-50-FC-FE-02-DB)

Glossary

Bridge: A bridge is an intelligent, internetworking device that forwards or filters packets between different networks based on data link layer (MAC) address information.

Default Gateway (Router): Every non-router IP device needs to configure a default gateway's IP address. When the device sends out an IP packet, if the destination is not on the same network, the device has to send the packet to its default gateway, which will then send it out towards the destination.

DHCP: Dynamic Host Configuration Protocol. This protocol automatically gives every computer on your home network an IP address.

DNS Server IP Address: DNS stands for Domain Name System, which allows Internet servers to have a domain name (such as `www.Broadbandrouter.com`) and one or more IP addresses (such as `192.34.45.8`). A DNS server keeps a database of Internet servers and their respective domain names and IP addresses, so that when a domain name is requested (as in typing "Broadbandrouter.com" into your Internet browser), the user is sent to the proper IP address. The DNS server IP address used by the computers on your home network is the location of the DNS server your ISP has assigned to you.

DSL Modem: DSL stands for Digital Subscriber Line. A DSL modem uses your existing phone lines to transmit data at high speeds.

Ethernet: A standard for computer networks. Ethernet networks are connected by special cables and hubs, and move data around at up to 10/100 million bits per second (Mbps).

Idle Timeout: Idle Timeout is designed so that after there is no traffic to the Internet for a pre-configured amount of time, the connection will automatically be disconnected.

IP Address and Network (Subnet) Mask: IP stands for Internet Protocol. An IP address consists of a series of four numbers separated by periods, that identifies a single, unique Internet computer host in an IP network. Example: `192.168.2.1`. It consists of 2 portions: the IP network address, and the host identifier.

The IP address is a 32-bit binary pattern, which can be represented as four cascaded decimal numbers separated by ".": `aaa.aaa.aaa.aaa`, where each "aaa" can be anything from 000 to 255, or as four cascaded binary numbers separated by ".": `bbbbbbbb.bbbbbbbb.bbbbbbbb.bbbbbbbb`, where each "b" can either be 0 or 1.

A network mask is also a 32-bit binary pattern, and consists of consecutive leading 1's followed by consecutive trailing 0's, such as

`11111111.11111111.11111111.00000000`. Therefore sometimes a network mask can also be described simply as "x" number of leading 1's.

When both are represented side by side in their binary forms, all bits in the IP address that correspond to 1's in the network mask become part of the IP network address, and the remaining bits correspond to the host ID.

For example, if the IP address for a device is, in its binary form, `11011001.10110000.10010000.00000111`, and if its network mask is, `11111111.11111111.11110000.00000000`

It means the device's network address is `11011001.10110000.10010000.00000000`, and its host ID is, `00000000.00000000.00000000.00000111`. This is a convenient and efficient method for routers to route IP packets to their destination.

ISP Gateway Address: (see ISP for definition). The ISP Gateway Address is an IP address for the Internet router located at the ISP's office.

ISP: Internet Service Provider. An ISP is a business that provides connectivity to the Internet for individuals and other businesses or organizations.

LAN: Local Area Network. A LAN is a group of computers and devices connected together in a relatively small area (such as a house or an office). Your home network is considered a LAN.

MAC Address: MAC stands for Media Access Control. A MAC address is the hardware address of a device connected to a network. The MAC address is a unique identifier for a device with an Ethernet interface. It is comprised of two parts: 3 bytes of data that corresponds to the Manufacturer ID (unique for each manufacturer), plus 3 bytes that are often used as the product's serial number.

NAT: Network Address Translation. This process allows all of the computers on your home network to use one IP address. Using the broadband router's NAT capability, you can access the Internet from any computer on your home network without having to purchase more IP addresses from your ISP.

Port: Network Clients (LAN PC) uses port numbers to distinguish one network application/protocol over another. Below is a list of common applications and protocol/port numbers:

| Application | Protocol | Port Number |
|-------------|----------|-------------|
| Telnet | TCP | 23 |
| FTP | TCP | 21 |
| SMTP | TCP | 25 |
| POP3 | TCP | 110 |
| H.323 | TCP | 1720 |
| SNMP | UCP | 161 |
| SNMP Trap | UDP | 162 |
| HTTP | TCP | 80 |
| PPTP | TCP | 1723 |
| PC Anywhere | TCP | 5631 |
| PC Anywhere | UDP | 5632 |

PPPoE: Point-to-Point Protocol over Ethernet. Point-to-Point Protocol is a secure data transmission method originally created for dial-up connections; PPPoE is for Ethernet connections. PPPoE relies on two widely accepted standards, Ethernet and the Point-to-Point Protocol. It is a communications protocol for transmitting information over Ethernet between different manufacturers

Protocol: A protocol is a set of rules for interaction agreed upon between multiple parties so that when they interface with each other based on such a protocol, the interpretation of their behavior is well defined and can be made objectively, without confusion or misunderstanding.

Router: A router is an intelligent network device that forwards packets between different networks based on network layer address information such as IP addresses.

Subnet Mask: A subnet mask, which may be a part of the TCP/IP information provided by your ISP, is a set of four numbers (e.g. 255.255.255.0) configured like an IP address. It is used to create IP address numbers used only within a particular network (as opposed to valid IP address numbers recognized by the Internet, which must be assigned by InterNIC).

TCP/IP, UDP: Transmission Control Protocol/Internet Protocol (TCP/IP) and Unreliable Datagram Protocol (UDP). TCP/IP is the standard protocol for data transmission over the Internet. Both TCP and UDP are transport layer protocol. TCP performs proper error detection and error recovery, and thus is reliable. UDP on the other hand is not reliable. They both run on top of the IP (Internet Protocol), a network layer protocol.

WAN: Wide Area Network. A network that connects computers located in geographically separate areas (e.g. different buildings, cities, countries). The Internet is a wide area network.

Web-based management Graphical User Interface (GUI): Many devices support a graphical user interface that is based on the web browser. This means the user can use the familiar Netscape or Microsoft Internet Explorer to Control/configure or monitor the device being managed.